

From **energy** to **eMotion**

ZEISS

Seeing beyond

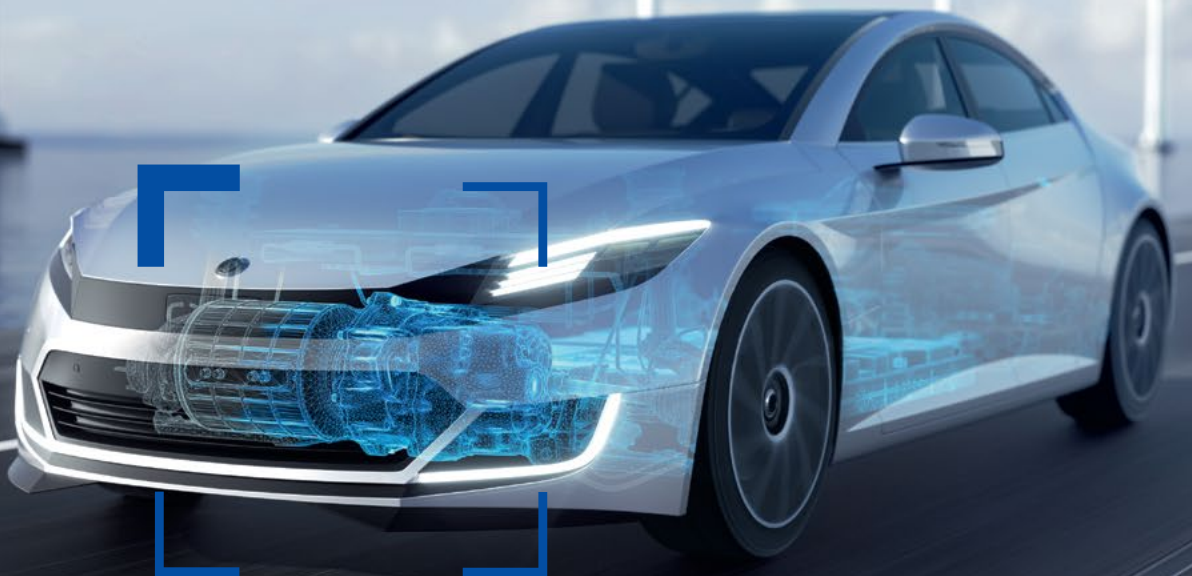

ZEISS eMobility Solutions

From energy to eMotion



Because of the large demand for electric vehicles all over the world, the automotive industry is seeing a rise of the electric engine and powertrain. This results in increasing demands on precision and poses new challenges to the quality assurance process. ZEISS Industrial Quality Solutions is the expert when it comes to developing new testing, inspection and metrology concepts for electric vehicle components. This has been achieved with joint projects, implemented in cooperation with the automotive and supplier industry.

ZEISS eMobility Solutions features a selection of products from the ZEISS portfolio, providing unique holistic quality inspection solutions for all components of the E-Mobility: Battery, Power Electronics, E-Motor and Transmission – From energy to eMotion.

ZEISS eMobility Solutions

POWER ELECTRONICS
page 28

FUEL CELL SYSTEM
page 18

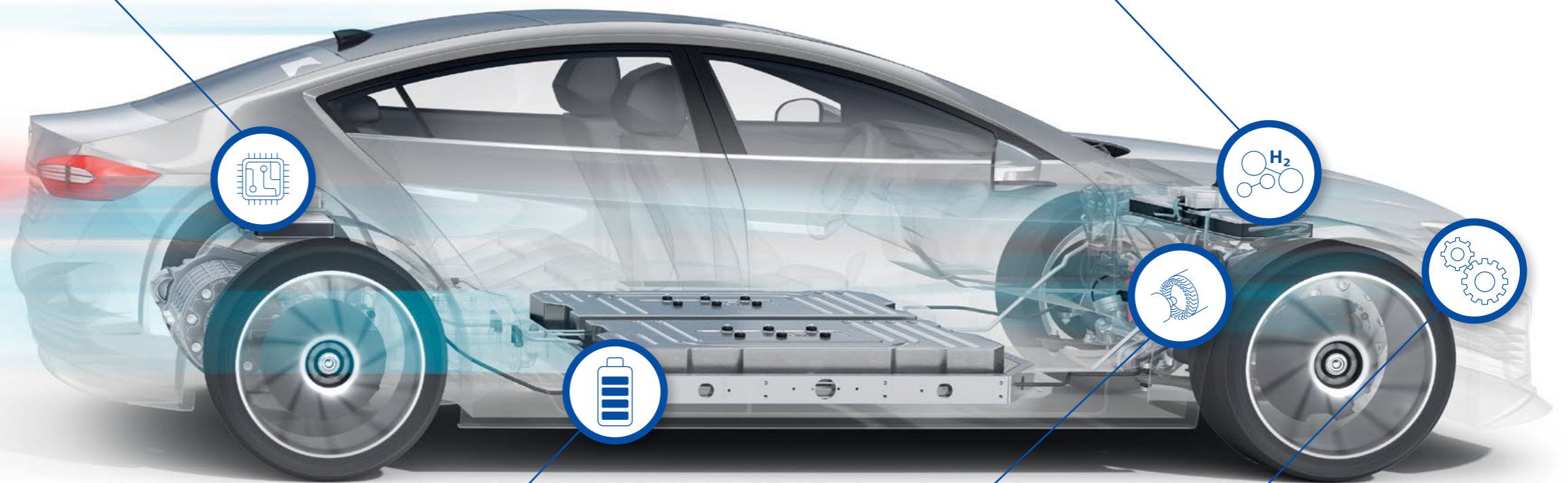

BATTERY
page 6

E-MOTOR
page 38

TRANSMISSION
page 50



Battery

A wide range of imaging, analytic and metrology tools are needed to enable battery research and quality control of batteries. ZEISS produces light, electron, x-ray-microscopy and computer tomography (CT) systems, as well as coordinate measurement machines to assess and correlate structural, compositional, electrical and dimensional characteristics across the relevant lengths scales. ZEISS thus helps to provide the relevant data to enable battery safety and performance for new energy vehicles.



Battery

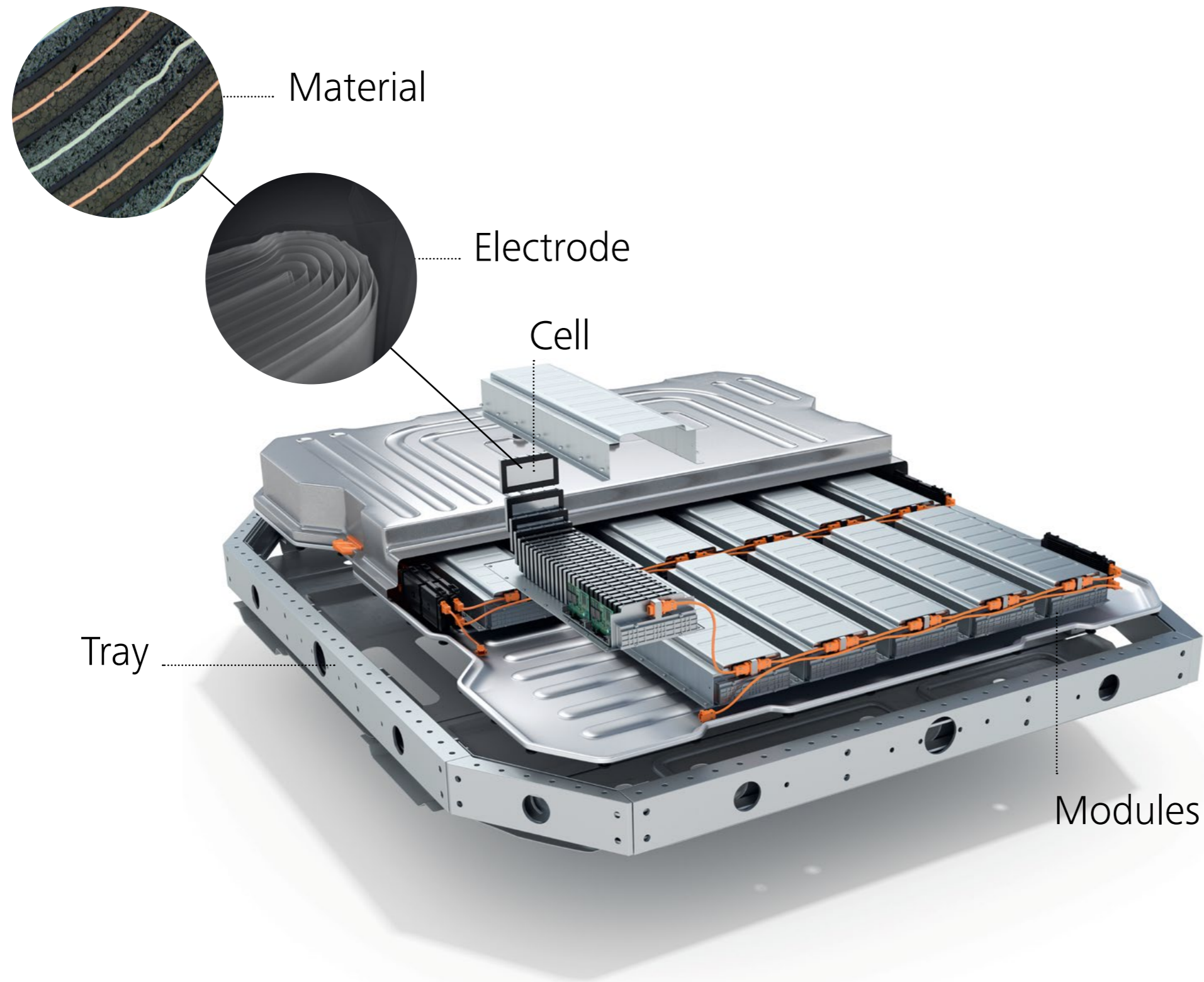

Batteries play an important role in the performance, range and longevity of an electric car. Safety, service life, performance and cost are essential to ensuring the success of battery technologies – both today and in the future. These factors need to be addressed every step of the way, from R&D to quality control and production. It's necessary to control and understand the properties of the battery down to the material, electrodes, cells, modules and tray level.

To produce efficient, reliable batteries that last, it is necessary to use top-quality materials and precise production techniques. Quality criteria range from selecting the best possible materials – including Lithium compounds, anode and cathode materials and separator foils – to control critical steps during the electrode manufacturing process. Understanding the microstructure and possible sources of contamination is key. It's also essential to build cells, modules and trays within very tight tolerances during final assembly.



Materials

Recipe Development

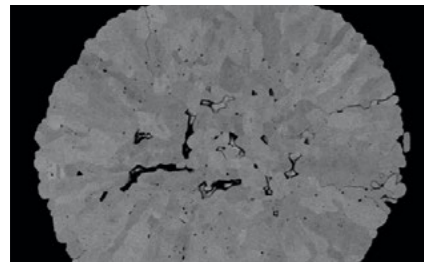

NCM 811 Cathode Material

Designing new energy vehicles for performance and cost begins with battery technology. Developing new active materials for the cathode, anode and separator is key to improve the capacity, charging behavior and lifetime while controlling costs.

For graphite anode materials, porosity and facile preparation are key to determine discharging behavior. While adding silicon to the anode can increase energy density, it is necessary to monitor and control lifetime issues. Electron and X-ray microscopy solutions from ZEISS provide the necessary imaging and analytical capabilities to determine the relevant material properties – critical for further advancing battery performance and safety.

Supply Chain Control

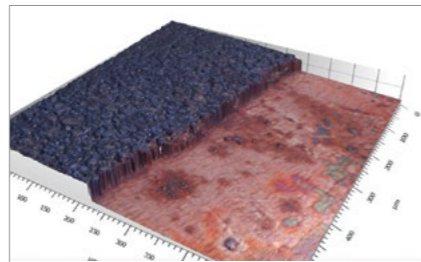

ZEISS Laser Scanning Microscope (LSM) Copper Foil Cathode

Controlling the quality of incoming goods is critical to ensure uniformity and consistency in the supply of materials. Key issues in supply chain control range from the qualification of raw material powders, and the quality control of the aluminum, copper and separator foils. Light and confocal microscopes from ZEISS can examine the surface roughness and microstructure of foils. Electron microscopes control the elemental composition, particle size distributions and/or particle contamination in raw material powders. Complete batteries can be investigated using X-ray microscopy to ensure a uniform supply.

Lifetime & Aging Effect

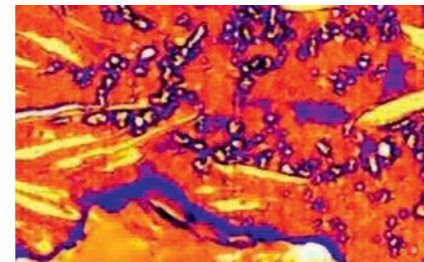

Conductivity Map Created with Electron Microscopy

The performance of batteries changes over their lifetime, and it's critical to understand these longitudinal aging effects. Under a microscope, one can observe that charging and discharging creates chemical and structural changes that alter the electrode materials. Repeated swelling and contracting of the battery leads to crack propagation, void evolution, loss of mechanical stability and electrical connectivity, and thus capacity fading or failure of the cell. ZEISS electron microscopy allows for microscale electrical property mapping, which makes it possible to create a "conductivity map" of the active battery materials.

The battery system defines the experience of driving electric vehicles more than any other element. The energy density of the cells defines power to weight ratio and driving range, and the time required for charging needs to align with customer expectations. The battery pack is often the most expensive component in a new energy vehicle. Raw materials dominate the cost of battery cells, which is why designing a new energy vehicle requires balancing performance against material costs without compromising safety. ZEISS microscopy tools give battery engineers and materials scientists the insights needed to overcome these challenges.





Battery Cell with Electrodes

A battery cell is the main unit of a battery, which consists of key components like the cathode, anode, separator and electrolyte. The geometry of the electrodes inside a cell is vital to the efficiency and safety of the cell. Anodes, cathodes and the separator foils are all cut or punched out of coated copper, aluminum or insulation paper foils. The separate foils are stacked, ideally without any overlapping.



Machine Vision

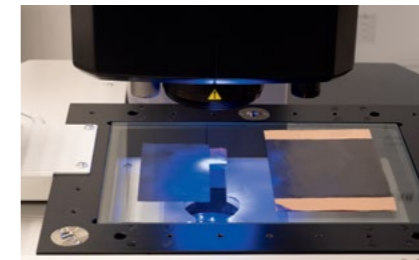

Electrode In-Line Inspection with ZEISS Machine Vision

Anodes and cathodes are coated with copper or aluminum foils. There are various possible surface defects like foil defect and surface cleanliness, but also coating defects such as bubbles, agglomerates and uncoated areas. ZEISS microscopes can effectively detect, locate and qualify the high variety of defects. It's necessary to detect defects during this high-speed production as well. An efficient ZEISS Machine Vision system can cover all of these requirements, controlling and monitoring at speeds that can ensure effective quality inspection at the same pace as the line.

Safety

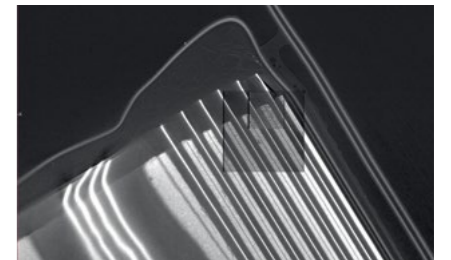

3D X-ray Microscope Tomography of a Pouch Cell

Batteries are energy dense objects, and like the fuel in conventional vehicles safety needs to be managed to protect the end user. Electrical shorting between anode and cathode can lead to thermal runaway and combustion – so the microscale properties of assembled cells can give insights into designing safer high performance batteries. Prior to cutting or disassembly, ZEISS X-ray microscopes can give internal 3D microstructure, show bending of current collectors and potential separator pinch points, as well as particle contamination which may lead to lithium dendrite formation. Shock and nail penetration tests use light microscopy to investigate potential failure modes following accident or collision. Charge and discharge behavior, swelling & dendrite formation can be observed using in-situ microscopy methods.



Modules with Cells

Pack with Cells

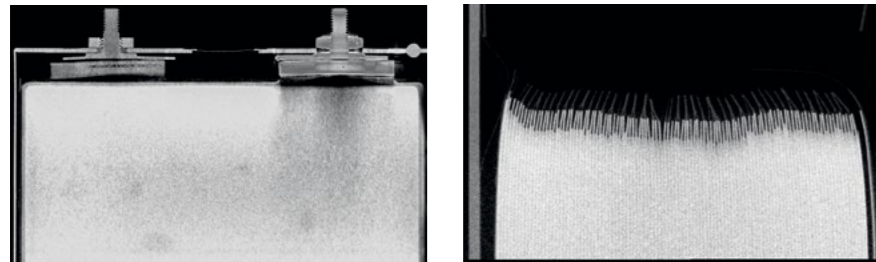

Plug-in Hybrid Electric Vehicle (PHEV2) Stacking Cell:
Complete Scan under Optimal Acquisition Parameters

For the battery cell itself the stacking of the battery sheets inside the cell is critical, since misplacement can lead to short circuits. Upon assembly of the cells the distances between the battery material and the cell housing needs to be controlled, as well as the position of the current collector foils and the welding quality for e.g. the sealing. Last but not least a defect free burst membrane and a correct electrolyte filling level needs to be assured to guarantee overall battery safety and performance. Non-destructive X-ray imaging and metrology can provide answers to the above questions and thus are also able to reveal quality issues in the battery cell assembly process.

Assembly & Safety



Battery Pack Including Stacked and
Connected Cells

A battery pack has a huge number of cells, which is why stacking and connecting them is a fully automated process. Robots bring all of the different cells and spacers between them together to create battery modules. Each complete battery pack consists of a few battery modules. ZEISS coordinate measuring machines are the ideal solution to make sure every single cell is in the right position in the tray. Non-contact measuring technology like ZEISS laser triangulation is safe and reliable due to the high voltage inside the battery packs. ZEISS X-ray technology is a fast, non-destructive solution to check the connection weld seams between the single cells – ensuring full functionality and capacity.

The battery cell is assuring the structural integrity of the battery and safely confines the electrolyte and the chemical reaction taking place inside. Since the chemical reaction is associated with the generation of heat and swelling of the battery material, the internal arrange of the battery components, the sealing of the cells and the arrange of the cells into packs needs to be controlled.

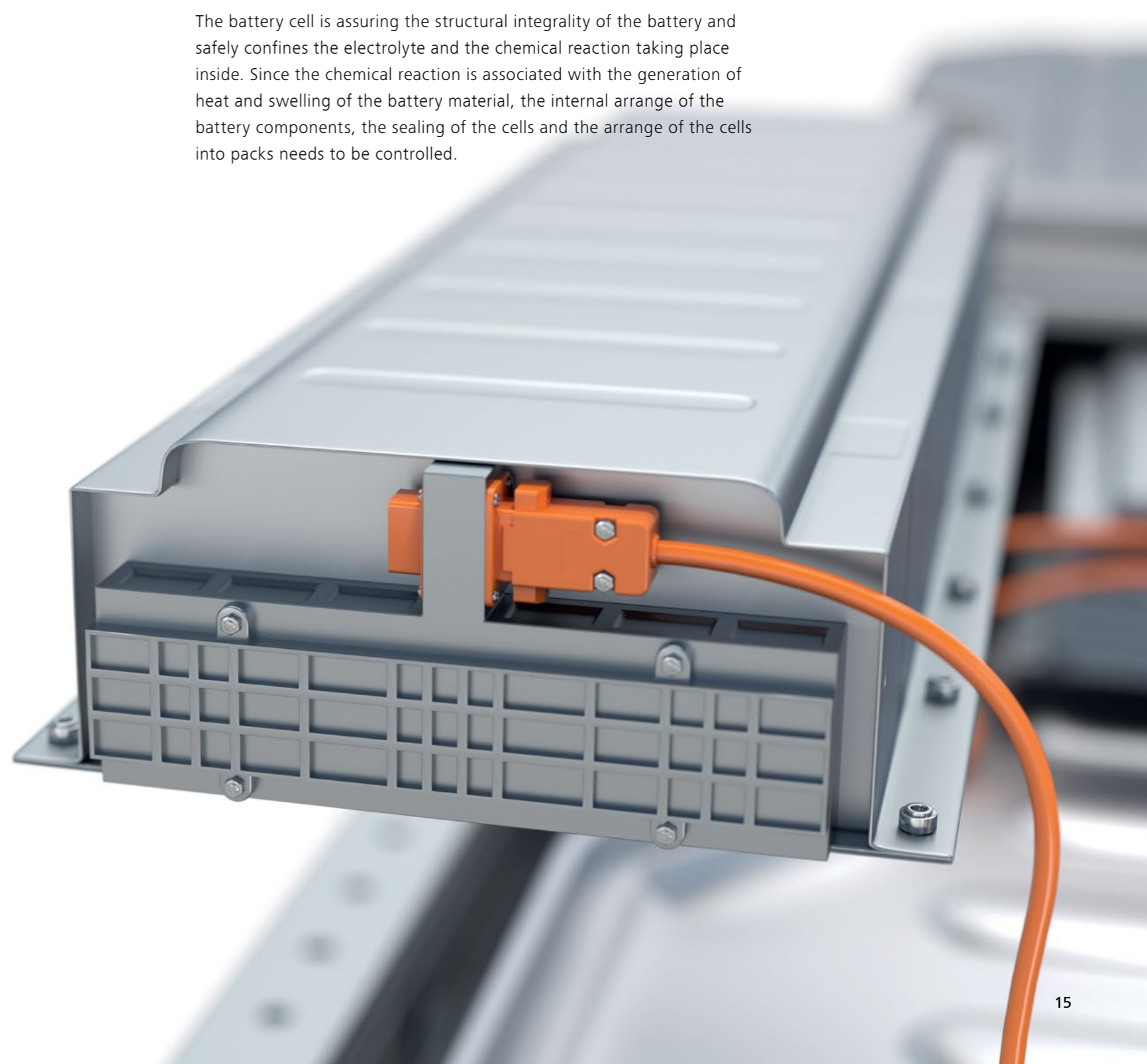



Battery Tray

The battery tray is the battery receptacle on the car. It must be mechanically stable and fastened to the entire car body. However, it is no longer a single part simply attached to an electric vehicle. Furthermore, the tray has become fully integrated into the car body. The complex aluminum weld design contains all the battery cells, connectors, and control units. Also, the battery packs including various number of battery modules.

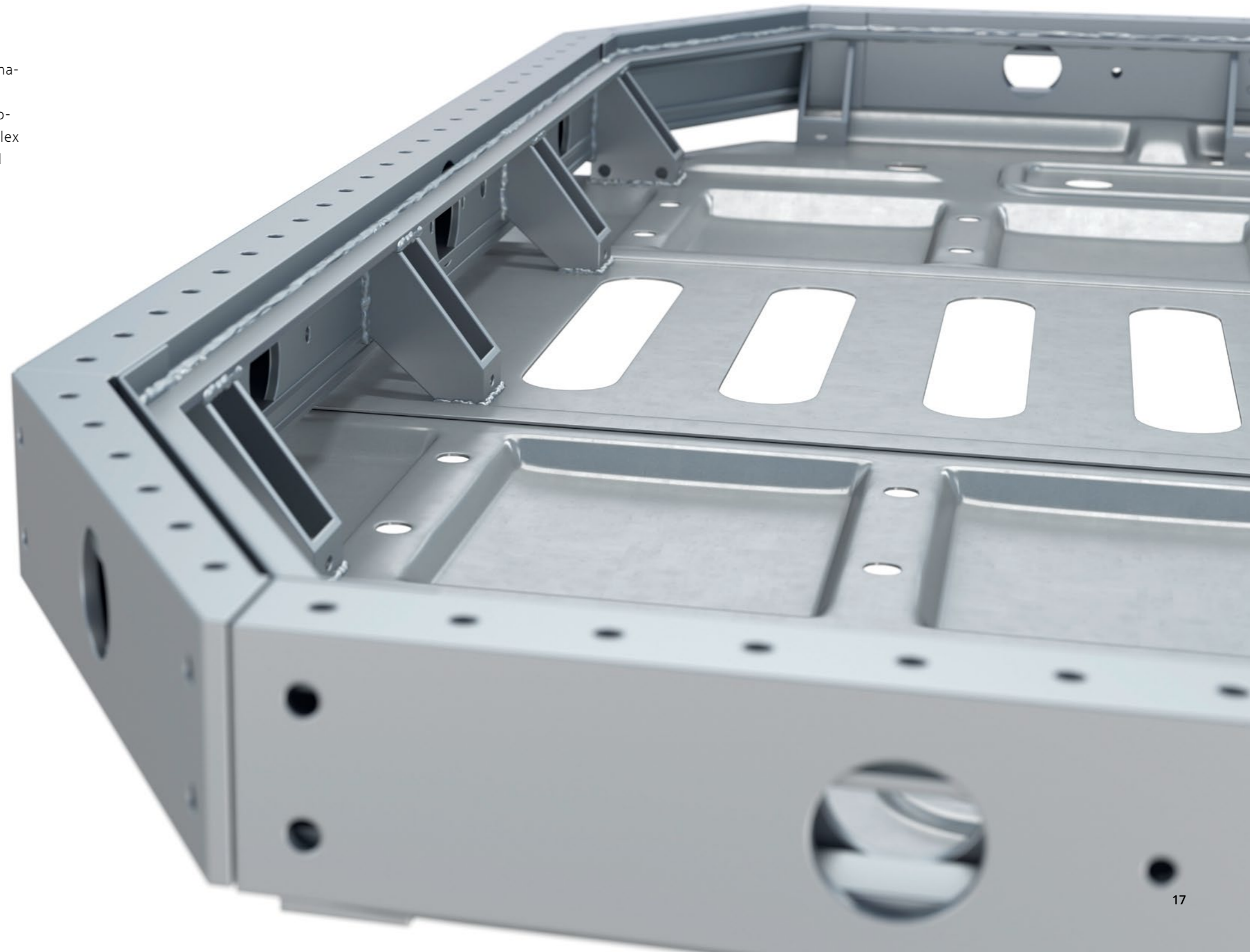



Position & Dimensions

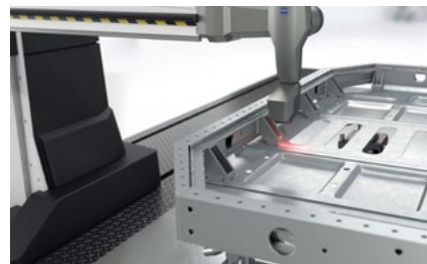

Optical Laser Triangulation
Measurement of Battery Tray on
ZEISS Horizontal Arm CMM

Thermal expansion of the battery pack during charging and driving can lead to torsion and bending in the tray. A variety of dimensional characteristics, such as the length, diameter and position of slots, must be measured either using random sampling or a complete automated inspection at the end of the line. The large number of features requires quick inspection cycles involving multi-sensor measurement. ZEISS non-contact optical laser scanners can quickly extract feature data, while tactile probe systems can reach undercuts and other challenging optical features.

Welded joints Quality



Tactile Measurement of Battery Tray
on ZEISS Horizontal Arm CMM

The tray must be properly integrated in the car body because of the large amount of energy in the battery cells – and to ensure the safety of the battery in the event of a crash. Connection points (i.e. welded bolts) attach it to the rest of the car body. The size and location of these welded points are important for the fully automated battery tray assembly process, and for the structural connection to take load forces during driving, charging and in case of an accident. All of these requirements lead to a wide range of different characteristics that could be covered with flexible user-defined probe systems or by scanning point clouds with ZEISS optical sensors.

Inline Measurement in production



Optical inline inspection of the
Battery Tray

Due to the high number of geometric elements and weld joints to be measured, as well as the size of the battery tray, long measurement and inspection cycles are quickly achieved. Since the battery tray, as a safety-critical component, is very often required to 100% monitoring, an inline solution for production is required in addition to the reference measurement in the measuring room, in which the most important elements are measured. ZEISS offers various sensor systems for inline measurement and inspection technology. The sensors are moved to the features to be measured by industrial robots, which means that a very short measuring time can be achieved without the need to additionally eject the battery tray.

Full-field geometry acquisition



Optical measurements of a battery tray
with a 3D measuring machine

Optical measuring machines from GOM enable the full-field measurement of the battery tray with high-precision fringe projection. They digitize the part within a short period of time from different viewing directions – with high accuracy and detail resolution. The sensors create absolute, correlation-free and traceable measuring data. The user gets millions of full-field distributed 3D coordinates that can be compared to the CAD model to detect deviations and identify defects such as deformations. By using CAD data and inspection plans, the software fully automatically creates sensor positions and robot paths required for acquisition.

Digital twin for process & quality control

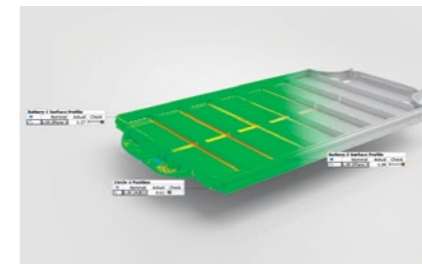

Deviations between the digital twin
and CAD data

The result of the measurement is the digital copy, a digital twin that shows the real geometry of the battery tray. Process-related inspection features, such as the location of the fixing holes, can be extracted from the 3D point cloud and be evaluated in a trend analysis. With trend analyses based on full-field measurements, changes in the production process can be spotted at an early stage. During problem analysis, the color-coded surface deviations of the 3D point cloud facilitate reaching the desired nominal CAD geometry. By using GD&T functions, the flatness or surface profile of sealing surfaces or individual battery compartments can be calculated. Likewise, the height and position of the sealing bead are easy to capture.

Digital assembly

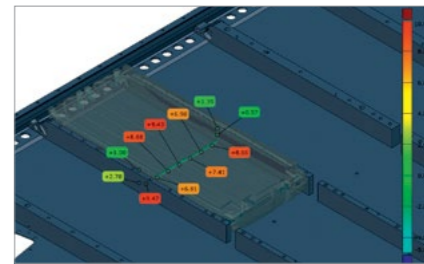

Determination of the gap size between
battery module and battery tray after
digital assembly

In the digital assembly, the interaction of the battery modules with the battery tray can be assessed. Assembly situations can be simulated and optimized via different local alignments. Questions about gap size changes caused by thermal deformation of the battery modules after cycle tests can also be answered easily. The surface deviations between battery module and battery tray can also be used to calculate the volume of the required heat-conducting paste for the individual battery compartments.



Fuel cell system

In addition to Battery Electric Vehicles (BEVs), Fuel Cell Electric Vehicles (FCEVs) are another possibility for the future of alternative energy supply. In a FCEV, the fuel cell system provides all of the energy needed to power the electric motor. The fuel cell stack is the most important component of the FCEV, this is where energy is being provided through electrochemical reactions. In the fuel cell stack many individual cells are arranged in series and connected together. The process to construct the fuel cell system requires the highest quality standards in production and development of each individual component. These requirements can be achieved by using ZEISS microscopy and ZEISS metrology solutions.

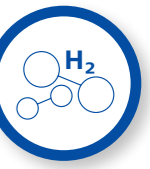

Fuel cell system

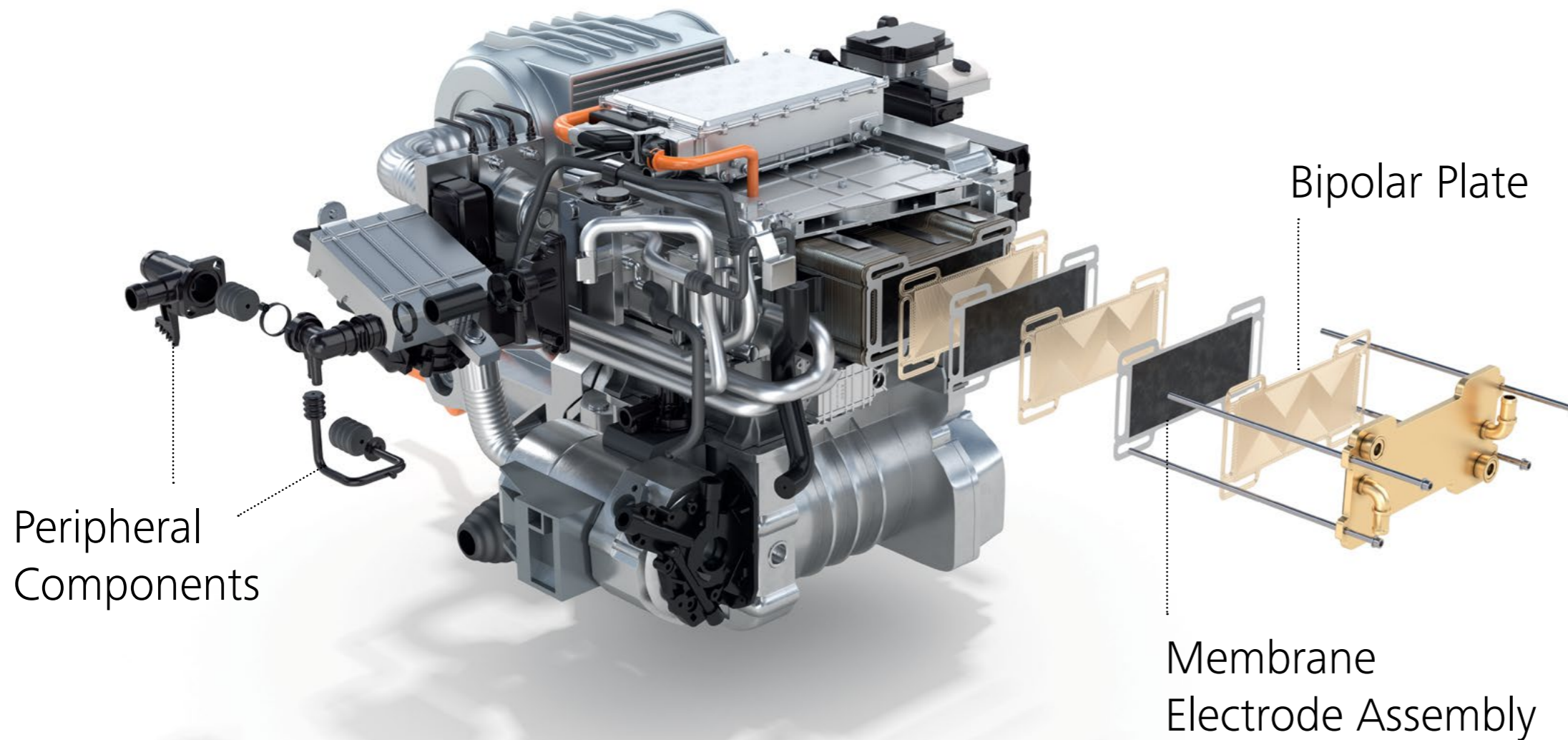

At the heart of every Fuel Cell Electric Vehicle is the stack of low-temperature fuel cells with polymer membranes (PEMFC); this is where the electrical energy will be extracted from hydrogen. Each cell consists of two bipolar half-plates and a Membrane Electrode Assembly (MEA). Because the fuel cells are connected in series, the quality of each cell is largely responsible for the overall system. The high demands placed on Bipolar Plates (BPP) and MEAs can be tested with dimensional metrology and by inspection of coatings, surface defects including contamination, or weld seams. ZEISS measuring instruments and image processing methods are used to meet the quality requirements within the entire value-added chain of fuel cell production. Multisensor CMMs, computed tomography and light microscopes make it possible to meet these requirements. The results are clearly provided on a component-related report, generated using the comprehensive ZEISS PiWeb software and the uniform software design of ZEISS solutions.

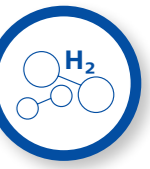

Bipolar Plate

2D Geometry

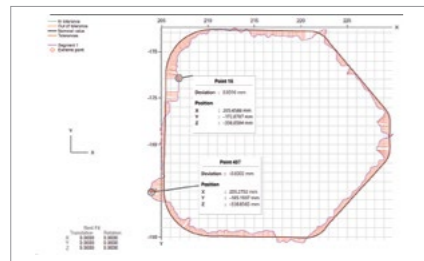
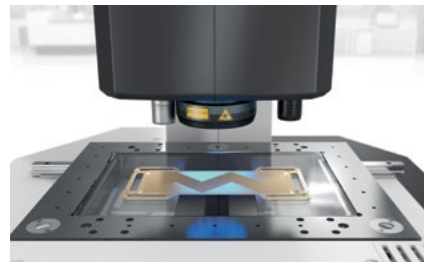

2D geometry analysis of a bipolar half-plate on the ZEISS O-INSPECT

For the large number of individual cells, optical measurement offers the necessary measuring speed and throughput. The dimensional accuracy of the outer contour, as well as recesses and holes for media routing, and geometric elements for stack alignment, can quickly and reliably be analyzed in a single plane with ZEISS O-INSPECT. This ensures the subsequent joining of each individual plate and the subsequent assembly of the stack using reference edges and patterns.

3D Geometry & Microstructure

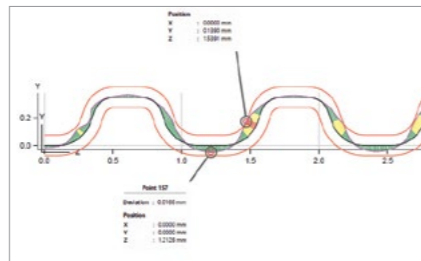

3D geometry measurement of a bipolar plate

Gas flow and coolant delivery are designed for high efficiency through specially designed microstructures in the individual bipolar plates. To guarantee the efficiency of the BPP the curvature, edge steepness, position and periodicity of the 3D microstructure must be ensured. The ZEISS DotScan, a chromatic white light measurement sensor, on a CMM with a rotating probe head is capable of optically measuring these characteristics. At the same time, the waviness and burr formation on cut edges can also be detected. With suitable measurement on both sides, the material thickness and local thinning of material by the forming process can also be recorded.

Bipolar Plate Assembly

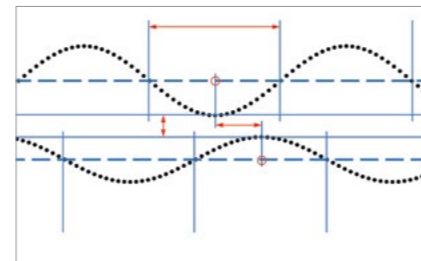
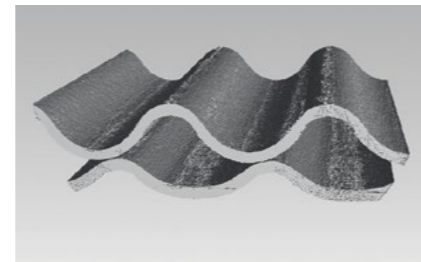

Analysis of the lateral displacement of a welded bipolar plate (BPP)

Two single half-plates are joined to form the bipolar plate. The circumferential weld seam seals the area of the coolant fluid, while additional welds in the so-called flowfield ensure electrical and mechanical properties. In this assembly state, the ZEISS DotScan chromatic confocal sensor can be utilized to capture the 3D structure on both sides. The goal is to determine the lateral alignment of the welded plates with respect to each other, as well as the deviation in the total thickness. Detailed 3D information in small areas can be obtained using X-ray microscopy with the ZEISS Xradia Versa.

Often, more than one hundred individual fuel cells are connected to construct a single stack. The bipolar plate is the link between two adjacent cells. It functions as a mechanical stability, the media flow and electrical connection to the next cell in the series. To efficiently generate electrical energy, the quality of each individual cell must be guaranteed.

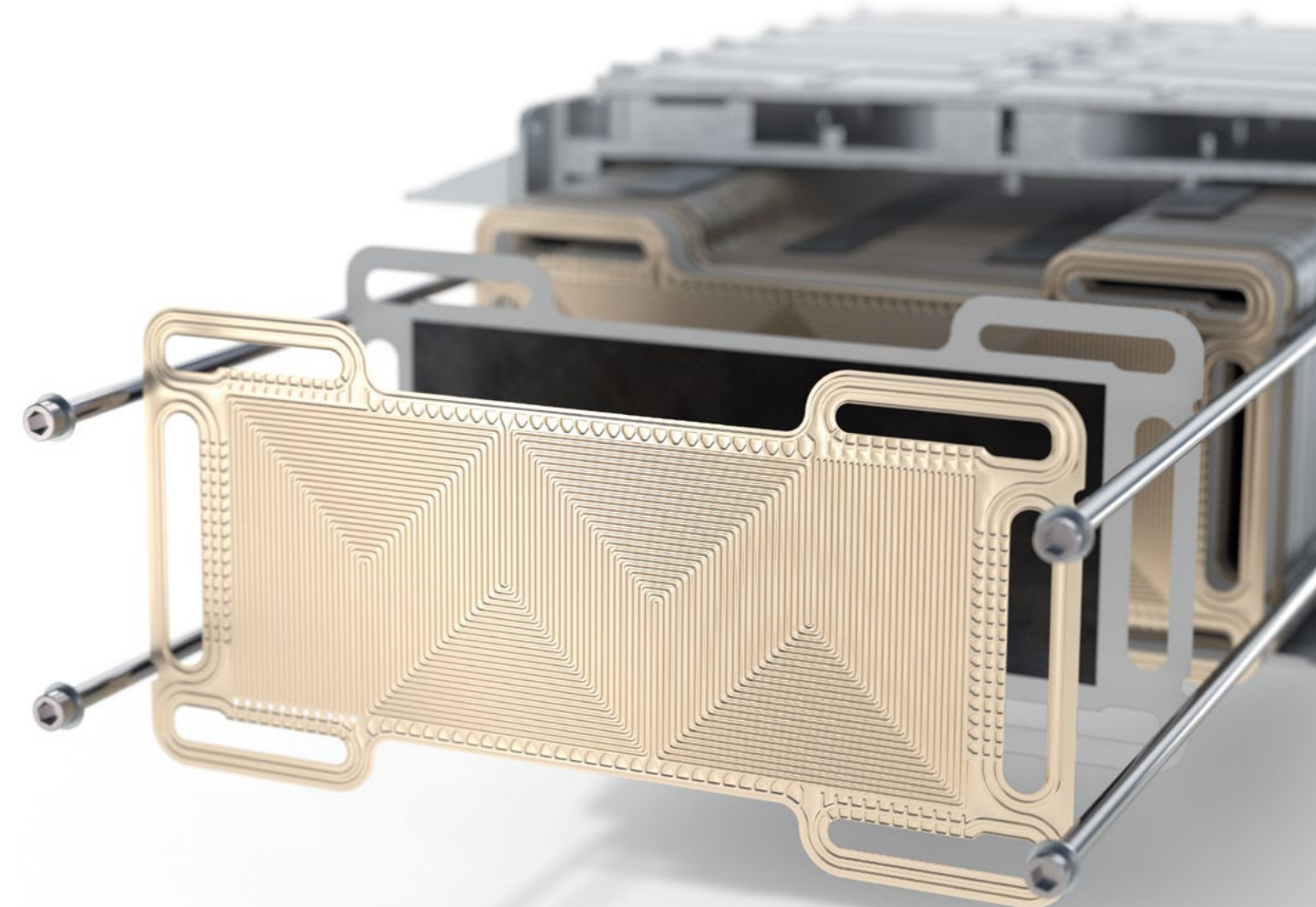

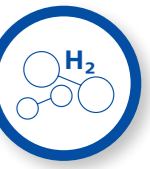

Membrane Electrode Assembly

Electrical energy is obtained from an electrochemical reaction that takes place in the Membrane Electrode Assembly (MEA). In the center of the MEA there is the membrane (PEM), which only allows the protons, i.e. the nuclei of the hydrogen atom, to pass through. Two electrodes, also known as „carbon black“, are positioned on each side of the membrane. They contain the catalysts that enable and accelerate the chemical reaction. The finished MEA additionally includes gas diffusion layers (GDL) on both sides. Depending on the manufacturing process, the electrodes are either applied to both sides of the membrane (CCM) or to the respective GDL (CCL).

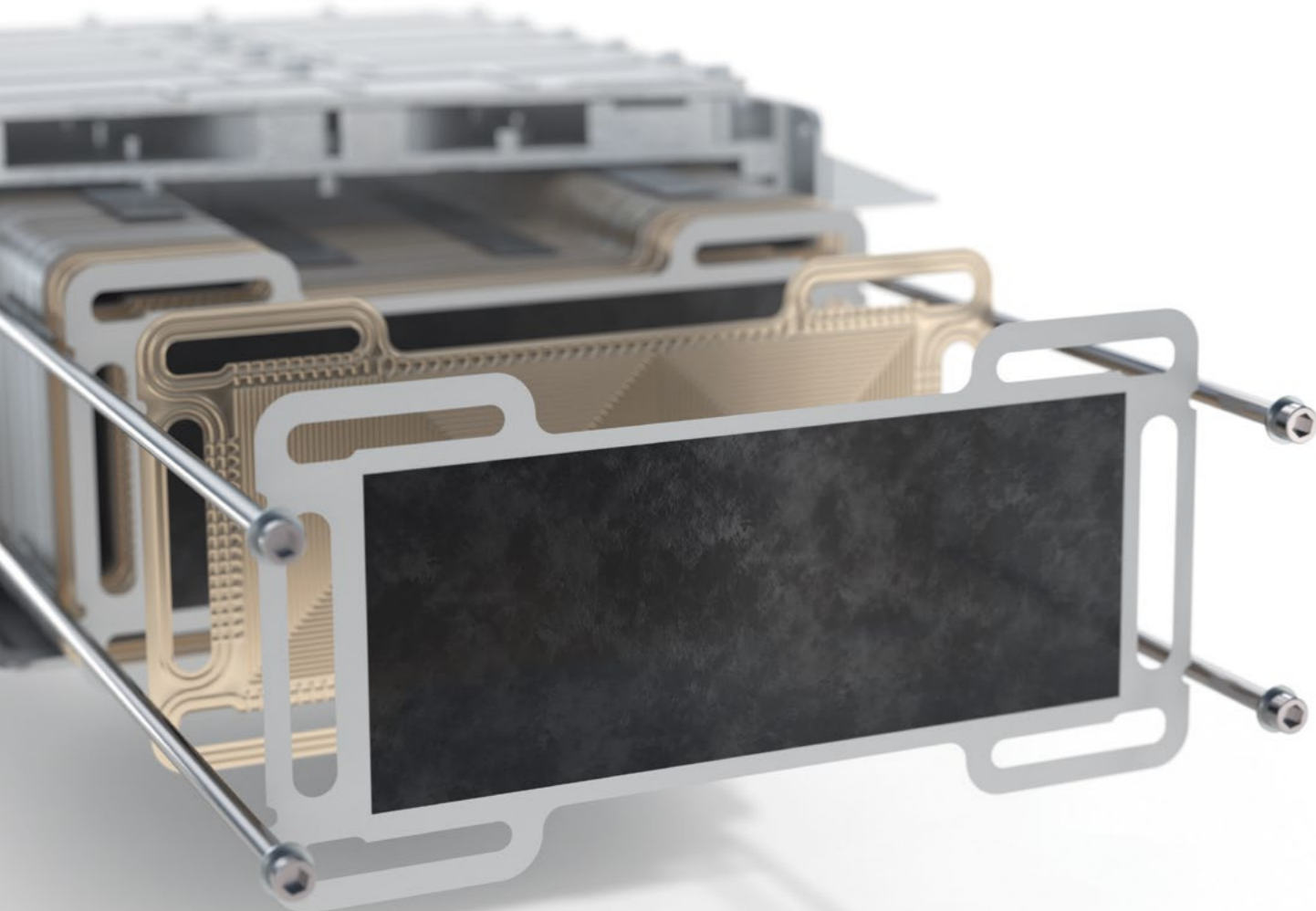

2D Geometry of Planar Single Layers

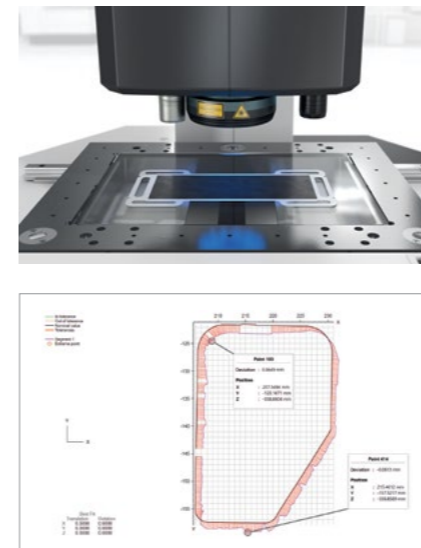

Measurement of a membrane electrode assembly (MEA) on a ZEISS O-INSPECT

The position and orientation of the individual layers, especially the electrodes, have a decisive influence on the efficiency of energy conversion in the fuel cell. In addition to CCMs or CCLs, unitized electrode assemblies (UEAs) are often used. The ZEISS O-INSPECT offers the perfect solution to measure the sizes and positions of recesses as well as the positions of coatings in relation to reference edges. These characteristics can easily be measured with the O-INSPECT's optical edge detection technology and its integrated background lighting.

Micrograph Analysis of the Finished MEA

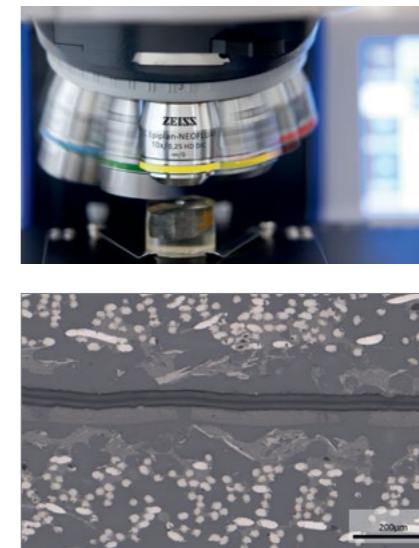

Light microscope image of a prepared micrograph of the MEA stack

During the development and testing of the layer structure of the MEA, samples sections are prepared through destructive testing procedures. Using these samples analyze the continuity of layers, their thicknesses and orientations with respect to each other are analyzed. Bright field or confocal microscopy is a perfect solution, for example using the ZEISS Axio Imager.

Defect Analysis of Electrode Layers



Electron microscope image of an electrode coating including crack network

The electrode layers are applied very thinly to the PEM (CCM) or GDL (CCL) with a coating thickness of only a few µm. Coating processes and handling can influence the crack formations on the electrode layer. The analysis of these cracks (width, length, branching, meshing) can be performed using light microscopic images, which can be captured using the ZEISS Axio Imager. Cracks can be further examined using scanning electron microscopes, such as a ZEISS GeminiSEM.

Peripheral Components

Stack Assembly

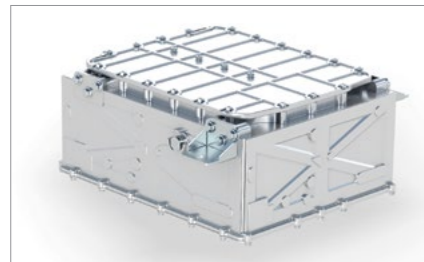

Stack assembly of a Fuel Cell System

The individual BPP and MEA units are packed tightly to construct a dense cell stack. The structural geometries are crucial as they must absorb the pressure within the stack during operation. The housing of the stack often consists of a die-cast aluminum construction. To ensure the quality of these components, ZEISS computer tomography is used to detect defects, pores or inclusions in the cast structure. In addition, machined connection surfaces are measured and evaluated to gauge the dimension, shape and position using tactile and optical coordinate measuring technology from ZEISS.

Media-Carrying Components



Porosity analysis of a media carrying plastic part

Complex pipe systems are responsible for supplying hydrogen and oxygen to the fuel cell stack, as well as removing cooling water. The geometry and material properties of these components are very important for the functionality and durability of the entire system. To ensure this, ZEISS computer tomography can capture 3D data from the real injection molded component, which can be used to detect internal defects using ZEISS software tools. In addition, wall thicknesses can be viewed and measured, and a complete nominal-actual comparison can be calculated against the CAD model.

Compressors & Pumps

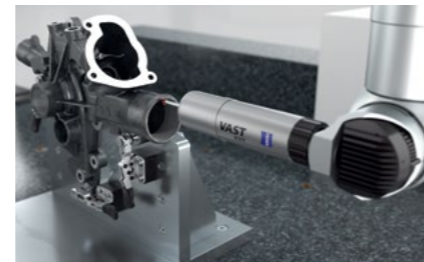

Tactile measurement of a pump on a ZEISS coordinate measuring machine

Compressors, pumps, and water separators are used to produce the proper conditions for the hydrogen and air to complete their chemical reaction and the transport. For these mechanical components, dimensional measurement technology plays a major role. Optical and tactile sensors on a ZEISS CMM can be used to certify the dimensions regarding size, shape and position of sealing surfaces, as well as bearing seats and other geometric elements.

In addition to the fuel cell stack, there are many additional components that are relevant to the system. The hydrogen required for the chemical reaction is transported from storage units to the stack via a piping system. In contrast, oxygen is obtained from the ambient air, which must be treated for this purpose. This process requires various components such as pumps, filters and water separators. The quality of each component is crucial in order to construct an efficient fuel cell system.

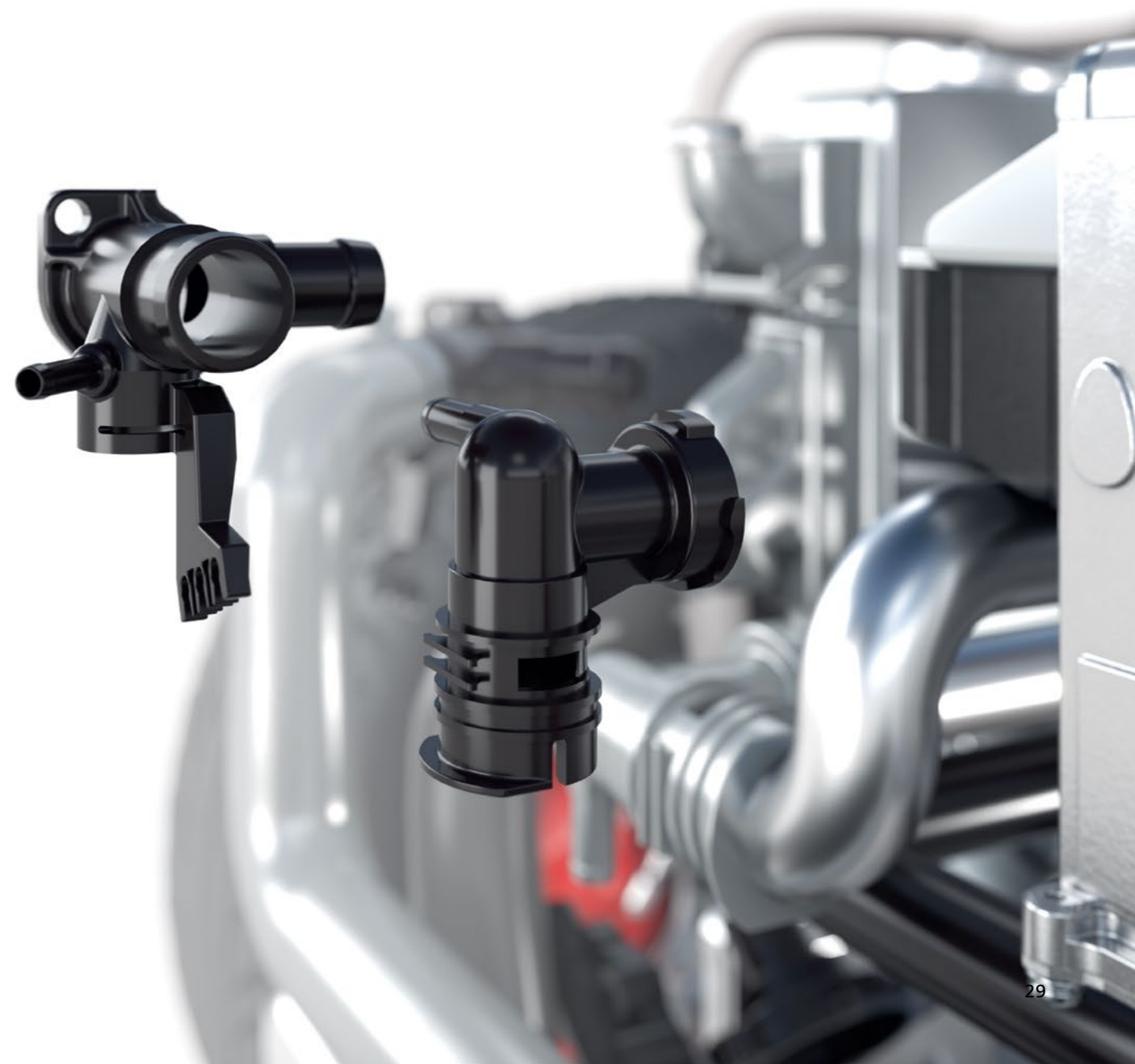

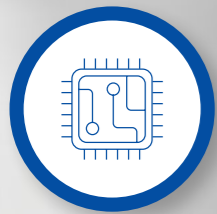
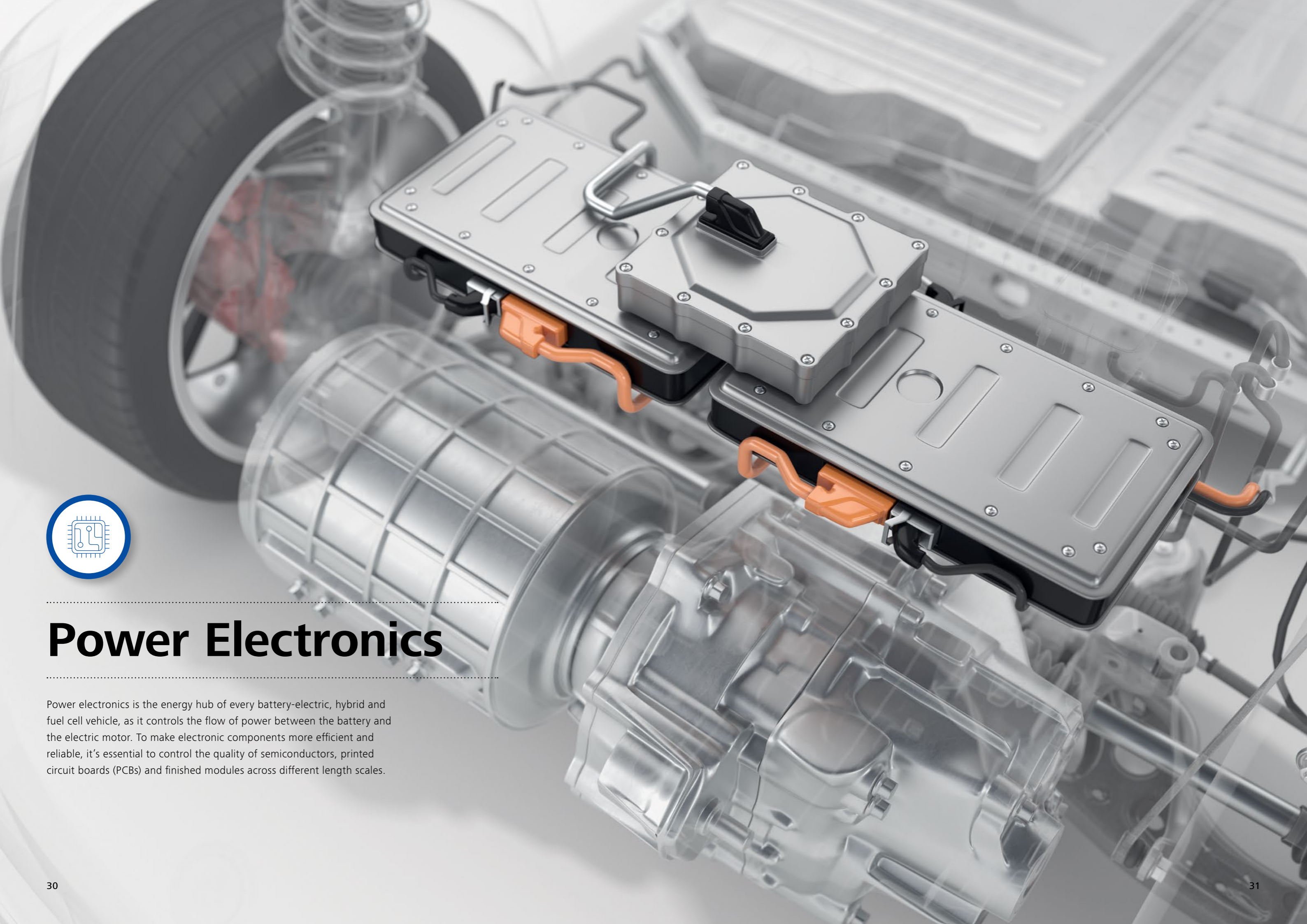

Power Electronics

Power electronics is the energy hub of every battery-electric, hybrid and fuel cell vehicle, as it controls the flow of power between the battery and the electric motor. To make electronic components more efficient and reliable, it's essential to control the quality of semiconductors, printed circuit boards (PCBs) and finished modules across different length scales.

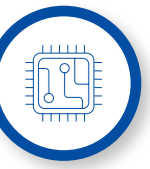

Power Electronics

Semiconductor

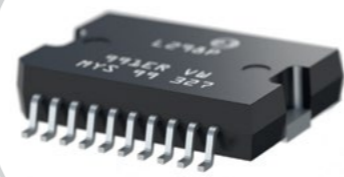
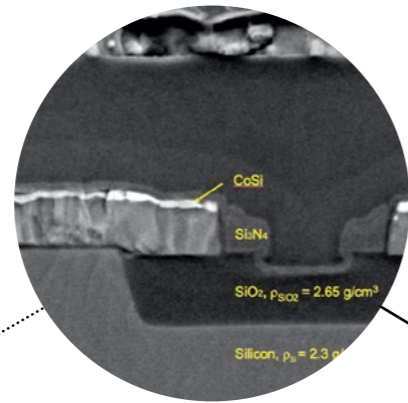

Printed circuit board (PCB)

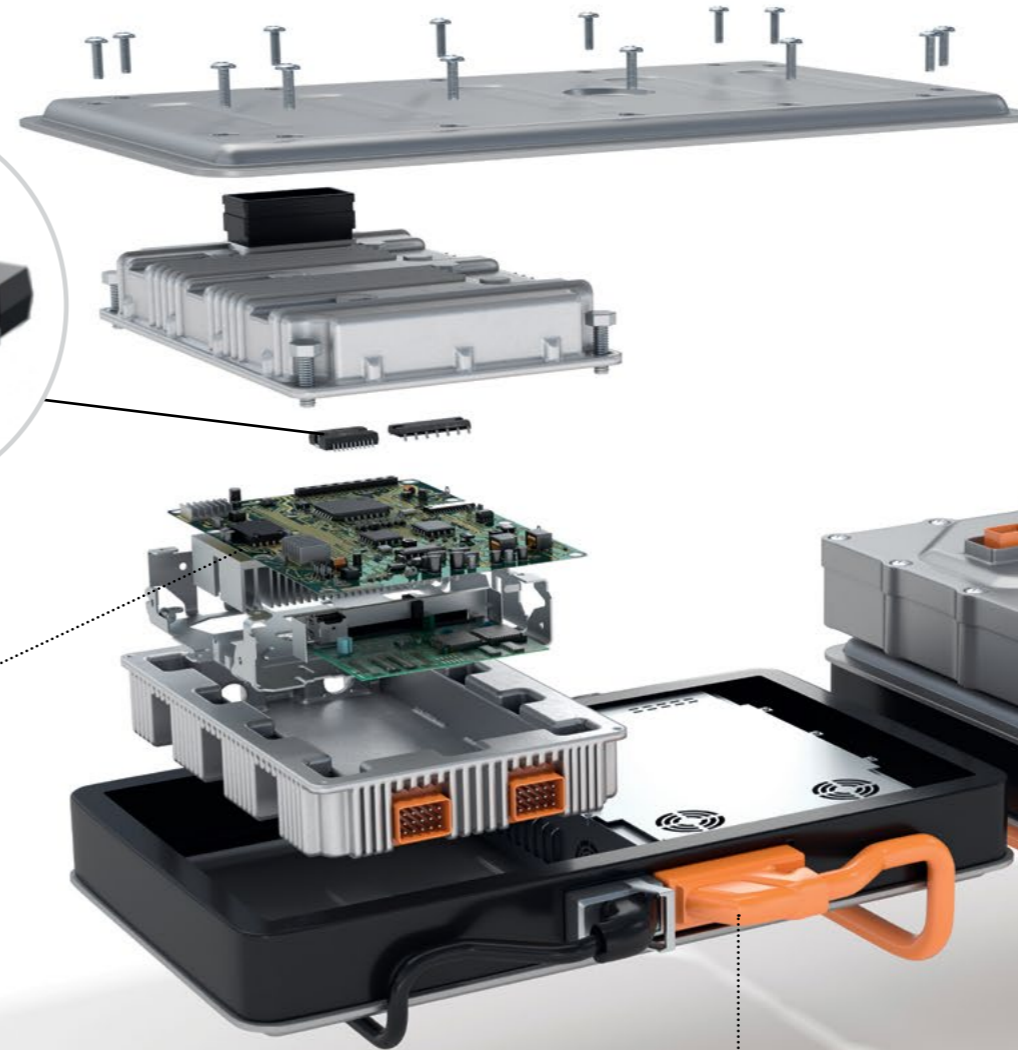

Housing

Connectors

Inspecting PCBs and connectors requires automated imaging and metrology solutions at the mm scale with μm precision. Non-destructive X-ray inspections and metrology solutions help benefit the quality control and failure analysis workflows of such components. Integrating electronic components in modules and then installing these in the electric vehicle involve very tight tolerances, which can be controlled using optical or tactile coordinate measurement systems. ZEISS has an extensive portfolio of products, including electron and X-ray microscopes for measurements down to the micrometer, as well as tactile measurement methods and automated image processing methods in the micrometer range.

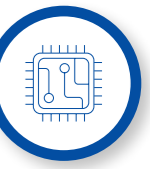

Semiconductor

Motor Control & Gate Drivers



Passive Voltage Contrast Image of an Integrated Circuit (IC) Using Electron Microscope

ZEISS microscope workflows are found throughout semiconductor IC design, manufacture and quality control. ZEISS Gemini technology offers a unique combination of material contrast, resolution and beam stability for electron microscopy of semiconductor logic devices. ZEISS X-ray microscopy can be used to identify manufacturing irregularities in semiconductor packages and guide improvements to process control, as well as non-destructively look for failure modes such as delamination and cracks in electrical contacts.

Power Electronics

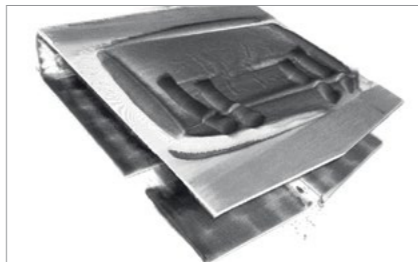

3D X-ray Tomography of a Power Diode

High-power switching devices, such as Insulated-Gate Bipolar Transistors (IGBT) and power Metal-Oxide-Semiconductor Field-Effect Transistors (MOSFET), are core technologies for delivering controlled power from battery to motor. Analytical electron microscopy techniques help map the electrical and material properties with submicron spatial resolution to optimize the design and failure analysis of these devices.

The control of the driving experience in new energy vehicles is increasingly compact and integrated within the electronic control system of the vehicle. Improvements in processing power, efficiency and cost allow vehicles to manage external sensor inputs, motor feedback and remote telemetry to augment driver inputs for a safe, efficient and enjoyable driving experience. ZEISS microscopy solutions are used throughout the Electronic value chain.

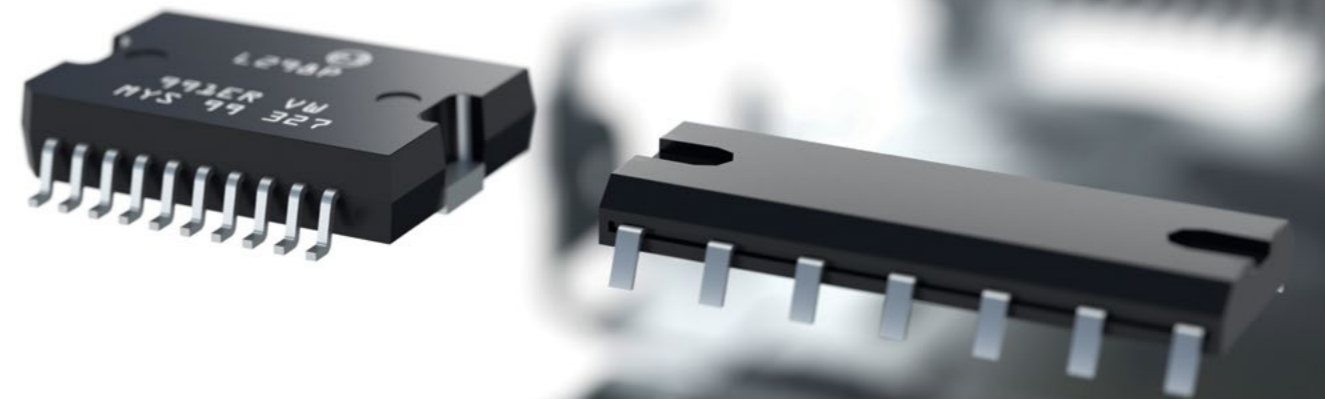

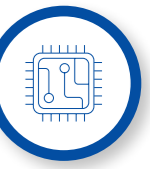

Printed Circuit Board (PCB)

The increasing number of electronic components, the ever tidier integration of such and the harsh environment (e.g. temperature, vibrations) makes the quality control and failure analysis of those components necessary. This is especially true for new energy vehicles and autonomous driving cars since the electronic devices become safety relevant.



Quality Control & Failure Analysis

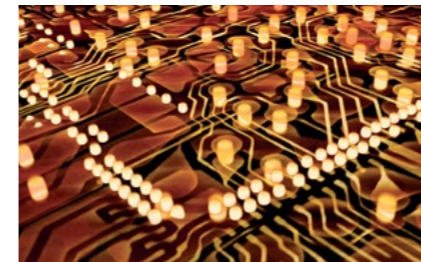

3D Visualization of a PCB Using X-ray Microscopy



Optical Cross-Section View of a Capacitor

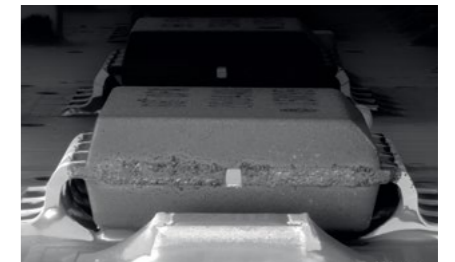

High-Resolution Electron Microscopy Imaging of Electronic Component on PCB

Non-destructive printed circuit board (PCB) inspection using X-ray technology and/or optical inspection can reveal quality issues, which guide steps in the failure analysis workflow to reveal the root cause. High-resolution imaging in 2D and 3D, analytical capabilities and optical metrology are needed to control critical dimensions, surface roughness and topography, and possible particle contamination. Automating such inspection tasks, including large-scale imaging, is required to produce increasing numbers of electronic components while meeting strict quality requirements.

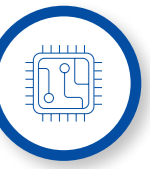

Housing & Connectors

Casting Inspection & Machined Dimensions



Housing of Power Electronics with Connectors

Aluminum die casting is used to produce thin, durable and light-weight casted walls. This saves material and allows for precise machining, essential for the fully automated assembly of the power electronics package. Sealing surfaces require tight tolerances in terms of flatness and roughness. The positioning of the connector plugs is also important to get electrical contact, which is reliable over a long time and many charging and driving cycles. ZEISS and GOM coordinate measuring machines are the best solutions to achieve geometry and roughness requirements as they cover all of the characteristics that involve tight tolerances, including the flatness and roughness of seal surfaces and the position of connector plugs.

Injection Molding & Connectivity

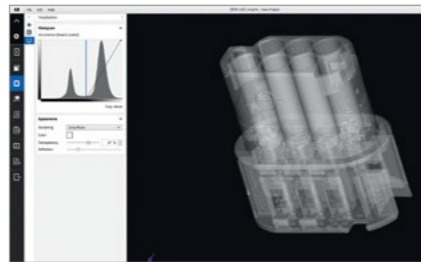

Connector X-ray Data Analysis with ZEISS NEO insights

Injection molding is the most commonly used technology to create connectors. This makes it possible to combine a mix of plastics for the connector housing and metal for the pins – a complex and very fast process because of the huge amount of connectors in a vehicle. The position of every single pin needs to be checked to make sure each electrical contact works. The small size of the pins inside the connector and the long and deep geometry to measure with tactile or optical technology present challenges. ZEISS X-ray scanning technology can overcome this, quickly measuring, visualizing and analyzing huge numbers of connectors. In addition to measuring tasks, the X-ray technology can also detect defects inside the injection molding areas.

The housing of the power electronics components plays an important role when it comes to safety and reliability of the whole battery pack. It needs to protect the battery electronics from external influences like vibrations, humidity and temperature changes, which could have a huge impact on failure safety. The connectors and plugs to the battery modules also need to resist these described influences, ensuring easy, safe connectivity every time the vehicle is used.



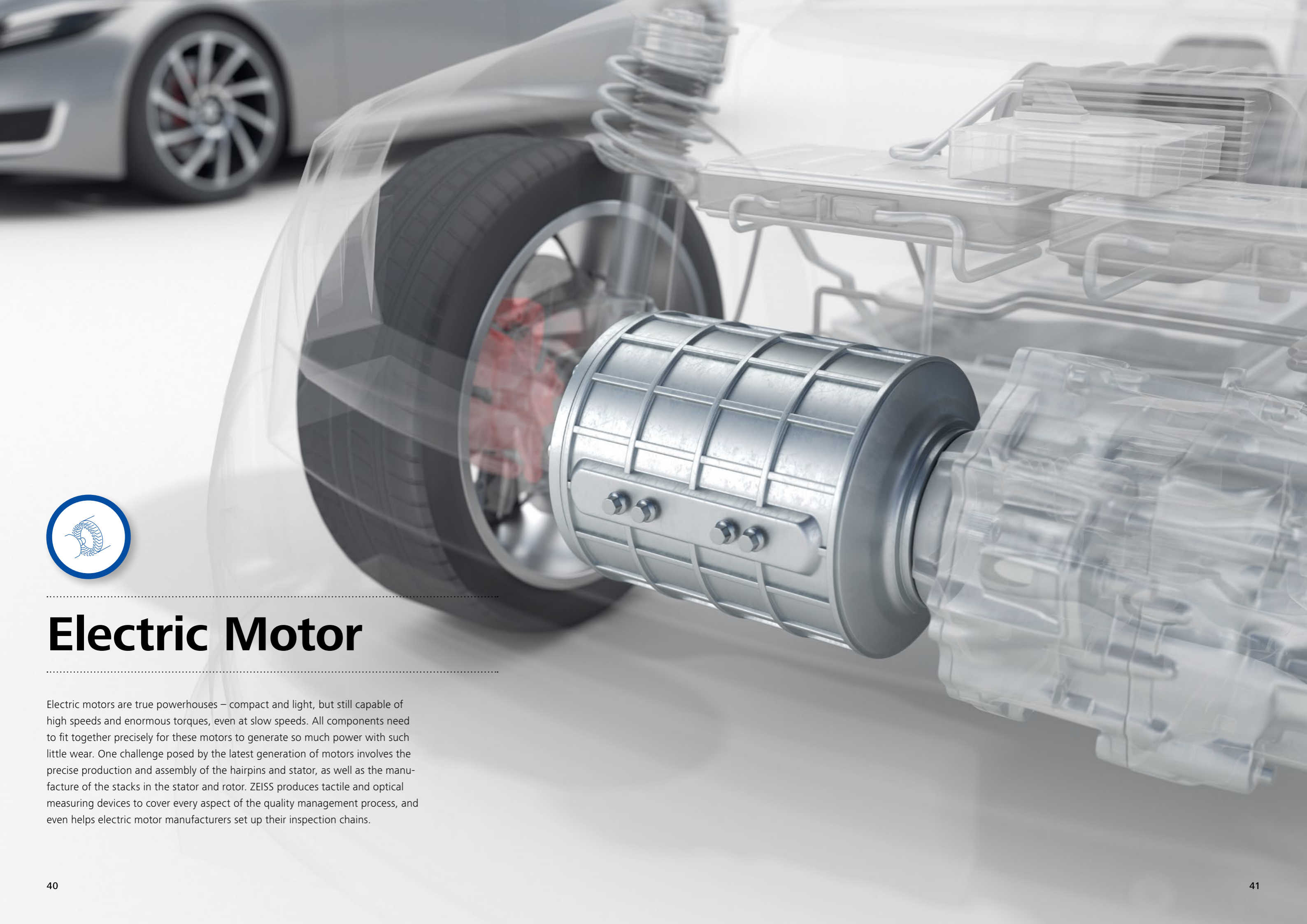

Electric Motor

Electric motors are true powerhouses – compact and light, but still capable of high speeds and enormous torques, even at slow speeds. All components need to fit together precisely for these motors to generate so much power with such little wear. One challenge posed by the latest generation of motors involves the precise production and assembly of the hairpins and stator, as well as the manufacture of the stacks in the stator and rotor. ZEISS produces tactile and optical measuring devices to cover every aspect of the quality management process, and even helps electric motor manufacturers set up their inspection chains.



Electric Motor

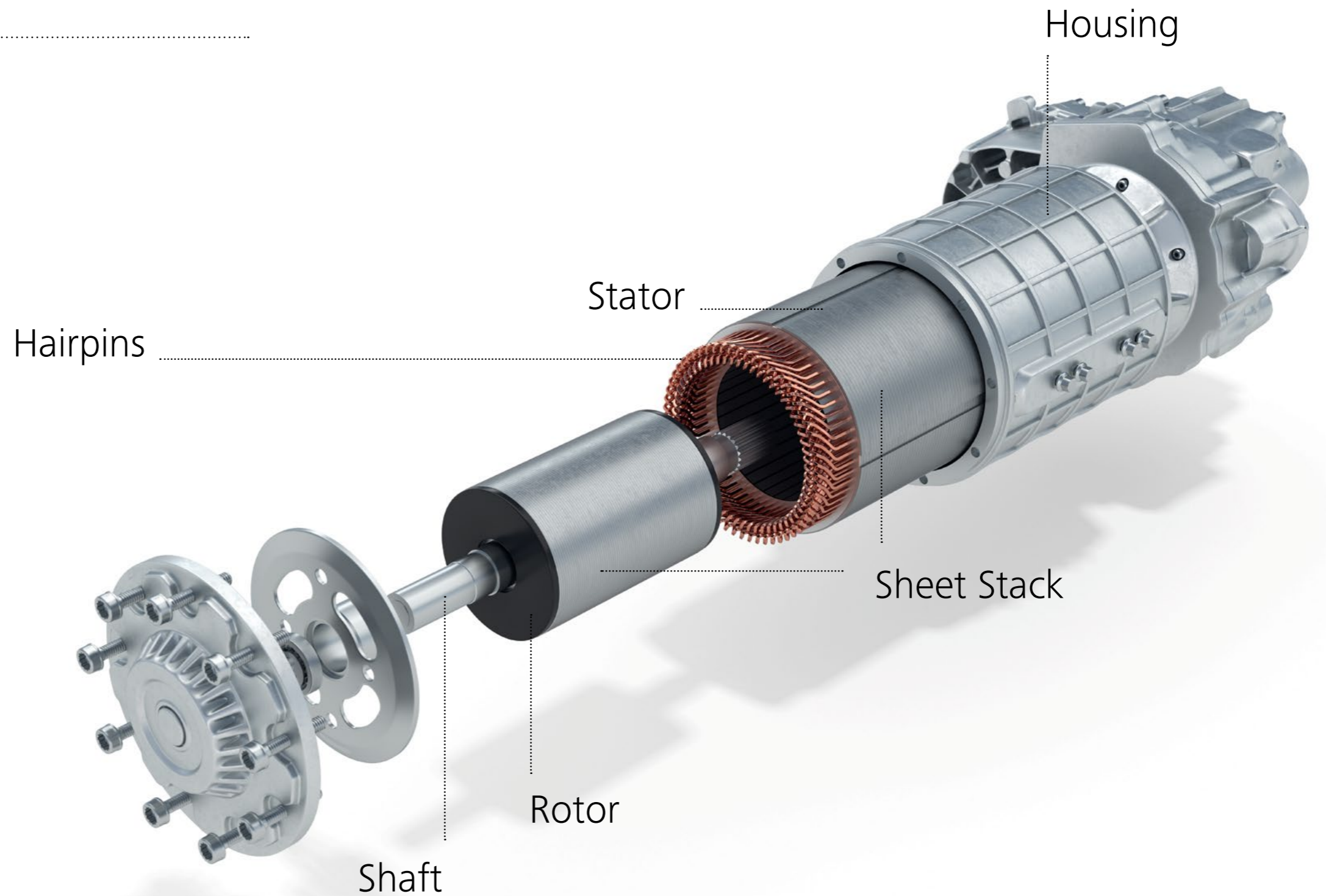

Automated processes are involved in producing many of the components found in compact high-performance motors. For example, the current-carrying conductors in the stator are no longer wound from many thin wires, but bent from solid copper wires, plugged together and welded. While this bending action is fully automated, it poses quality assurance challenges to measure the pin shape and isolation lacquer thickness due to the flexible structure of the pins. Eventually, these hairpins need to fit into the exact grooves punched or cut into the stator stack sheets. Such high-precision assemblies require down-to-the-micrometer accuracy – and this is where ZEISS excels.

ZEISS offers tactile and different optical measuring devices such as 2D camera, laser triangulation and confocal whitelight sensors to cover every aspect of the quality management process – for efficient, reliable motors that last. From handheld laser scanners to high-accuracy coordinate measuring machines, these devices are used in essential quality controls at multiple points throughout production – from the prototype stage to the assembly line, in two or three dimensions. As an expert in precision engineering, ZEISS can also design and set up the ideal inspection chain for every manufacturer.



Hairpins

Dimension & Coating Quality

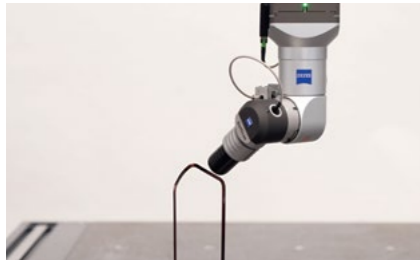

Hairpin Measurement on CMM with Confocal Whitelight Sensor or Handheld Laser Scanning

Each hairpin has a flexible structure and is coated with a sensitive lacquer layer – these characteristics create challenges for reliable tactile inspection. An automated ZEISS coordinate measuring machine, equipped with confocal light or laser triangulation optical sensor is one option to accurately measure the shape and lacquer thickness. Another more manual, flexible tool is a standalone ZEISS optical fringe projection sensor or a ZEISS hand-held laser scanner.

Bending Design Qualification

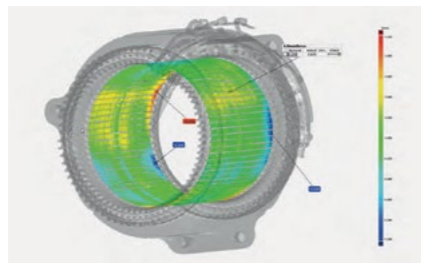

Hairpin Digitizing with the fringe light projection system ATOS Q

The design of a hairpin is not simply defined by a CAD model, but developed in many loops through the configuration of the bending parameters. It's necessary to scan and produce CAD models to evaluate finished hairpins in relation to a master pin. Fringe projection and laser triangulation a high-resolution point clouds of the hairpins. ZEISS Reverse Engineering software can quickly turn these into high-quality CAD models.

In the latest generation of e-motors, the current-carrying conductors inside the stator are no longer wound from thin wires, but bent from solid copper into hundreds of hairpins. These pins have individual shapes and differ when it comes to the length, angles and cross-section of copper. Using hairpins increases the amount of copper in the stator slots, which boosts efficiency. This is why the dimensions and quality of the stator are so crucial.

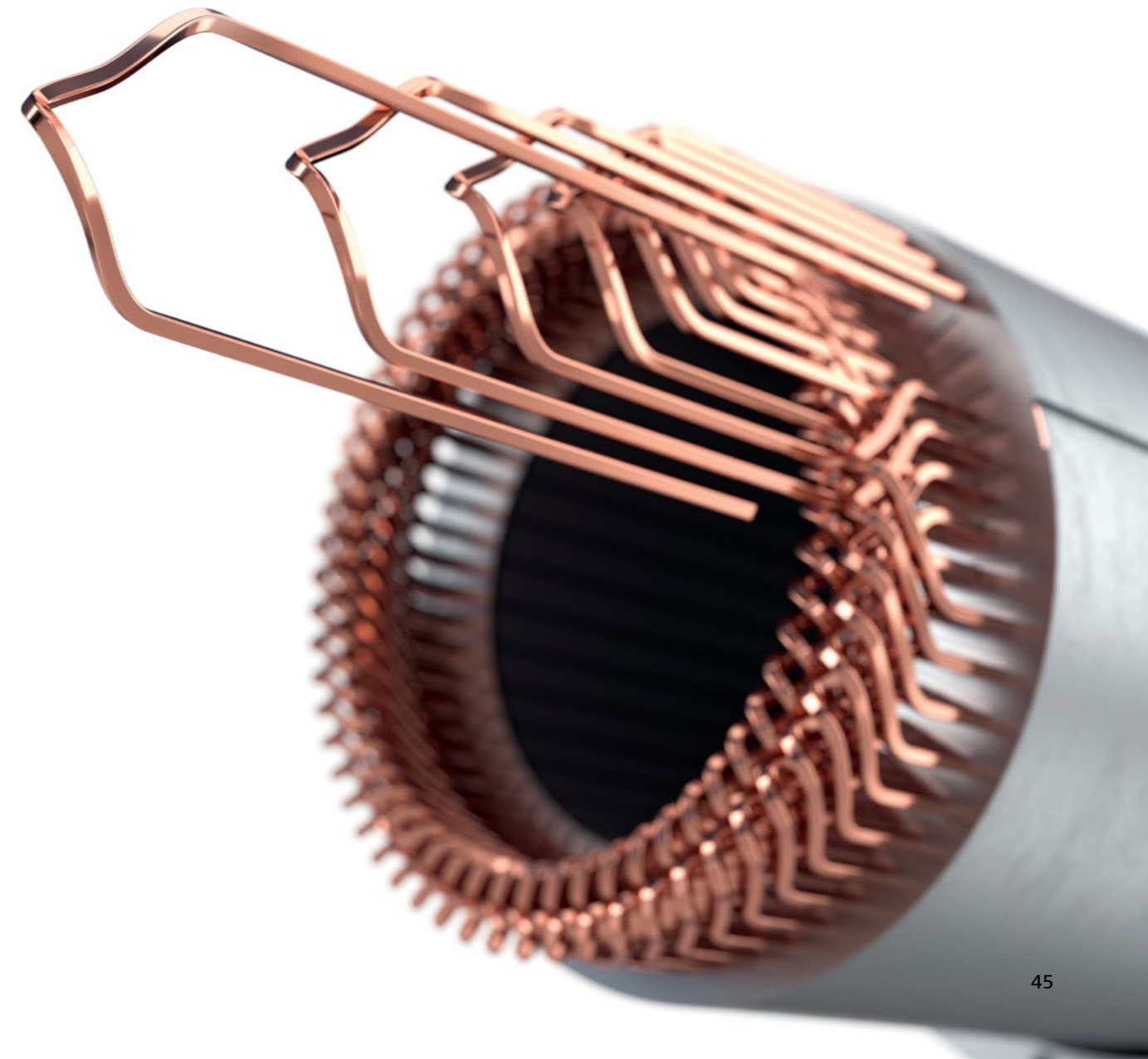



Sheet Stack

The sheet stack is built out of many single sheets, including crosssection slot geometry for the hairpins, permanent magnet slots and the outer- and inner diameter of the sheet stack assembly. Single 2D sheets provide the foundation for constructing sheet stacks for rotors and stators. The single sheets are either punched or laser cut from electrical steel sheets, and are less than 1mm thick. The final sheet stacks require a large quantity of individual sheets.

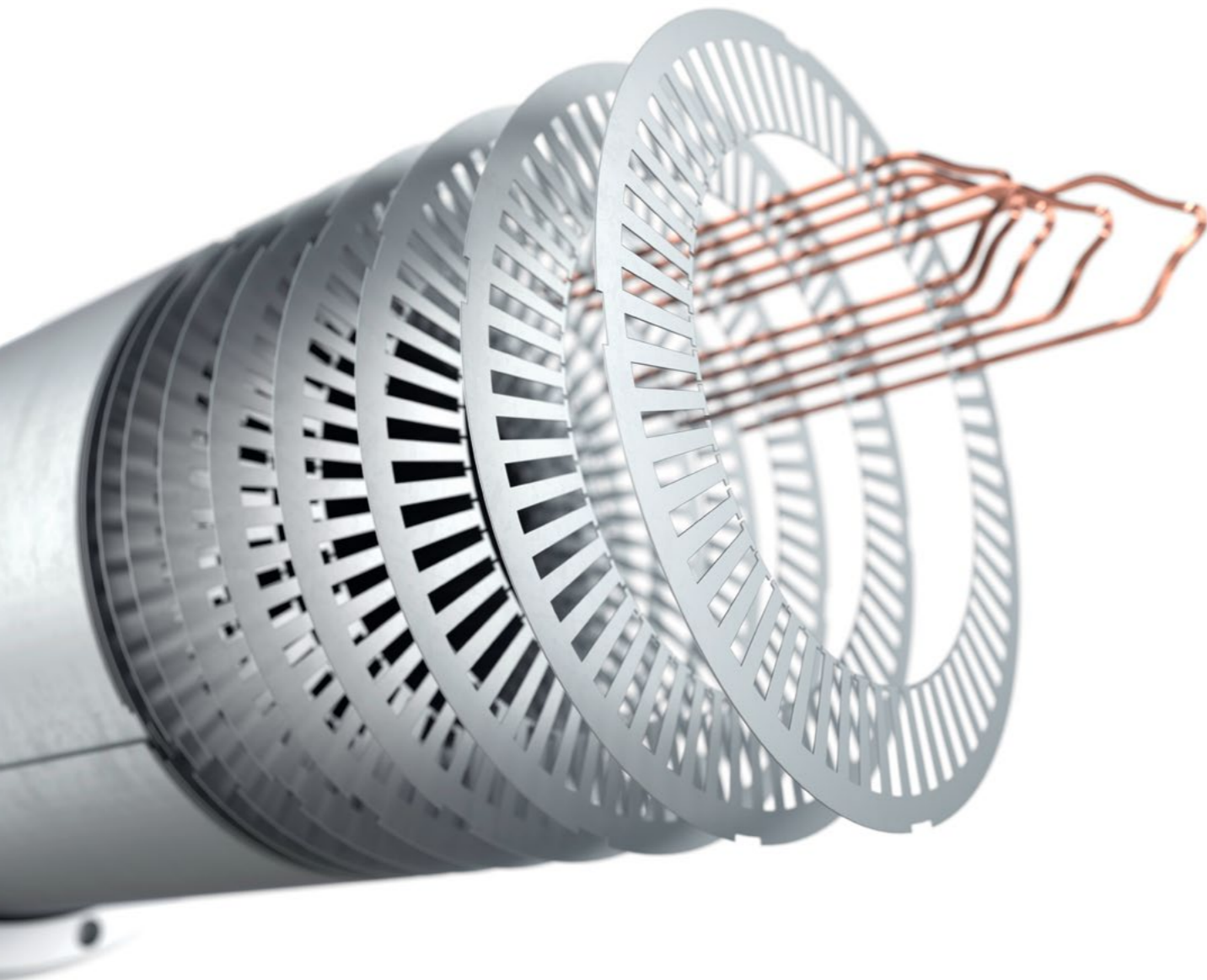

Sheet Inspection



Single Sheet Inspection on ZEISS Multisensor CMM

The geometry of the 2D sheet defines the dimensions of the final stator and permanent magnet slots. This is why it is so important to measure these dimensions quickly and with high accuracy. An ideal solution is to utilize ZEISS multisensor technology, such as 2D cameras and confocal light sensors, to measure the flatness of each individual sheet. The flatness and the non-existence of burrs are key factors to ensure a sheet stack that is perfectly constructed and easy to assemble.

Assembly Quality



Tactile Sheet Stack Measurement on ZEISS Bridge-type Multisensor CMM



Contour Measurement with Confocal Whitelight Sensor on ZEISS Bridge-type CMM

During the assembly of the sheet stack, the positioning of the single sheets for laser welding has a major impact on the geometry of the stator and rotor slots, which are mated with the hairpins and the magnets. After welding, it is important to inspect the dimensions and positions of the slots, as well as the height and diameters of the sheet stack. The contour features on the assembly are also important for the process of inserting the hairpins and magnets. ZEISS multisensor coordinate measuring machine can be combined with 2D cameras and whitelight confocal sensors to perform even more thorough inspections – for quality assurance you can rely on.



Stator

Dimensional Metrology



Measurement of Contour and Dimensional features together on one ZEISS CMM

During the stator assembly, the insulation paper and hairpins are inserted into the slots of the sheet stack and welded together. The power supply connection points are also welded. A number of characteristics require inspection, such as the positions of the laser-welded ends, to avoid short circuits in the stator. Flexible tactile and optical technologies are necessary to get accurate inspection results on positions and dimensions due to the very flexible copper hairpins – a ZEISS multisensor coordinate measuring machine.

Weld Seam Inspection

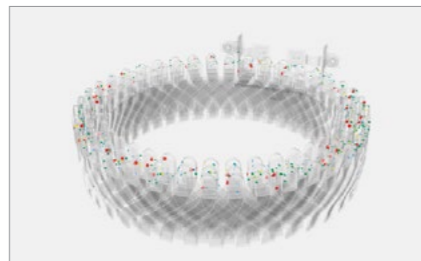

Inspection for Defects in the Weld Seam with ZEISS X-Ray Series

The hairpin ends must be laser-welded to allow current to flow through the stator, generating the electric field. In the weld process, remaining lacquer material on the stripped pins or bad welding parameters can cause porosity in the weld seams – and result in poor performance or the total breakdown of the e-motor. ZEISS computer tomography (CT) technology can detect, locate, classify and rate the internal pores of the weld, finding defective stators in a non-destructive quality assurance process.

Assembly Volume Analysis



Laser Scanning of the Stator – Handheld or Automatically on ZEISS CMM

The outer boundary of the stator is crucial for mating the stator in the e-motor housing. The connection flange and shaft position require inspection in relation with the transmission. It is essential that this data be collected quickly and thoroughly. These requirements can be achieved by using ZEISS laser line triangulation technology. This handheld, flexible option saves programming time to have measuring results available quickly – or an automated ZEISS coordinate measuring machine is ideal for higher quantities.

The stator is responsible for the latest generation e-motor's performance. This component has the biggest potential to improve the performance, power and efficiency of an e-motor. New raw materials and innovative manufacturing technologies make quality assurance across all production steps necessary to guarantee the safety, reliability and performance of the e-motor.

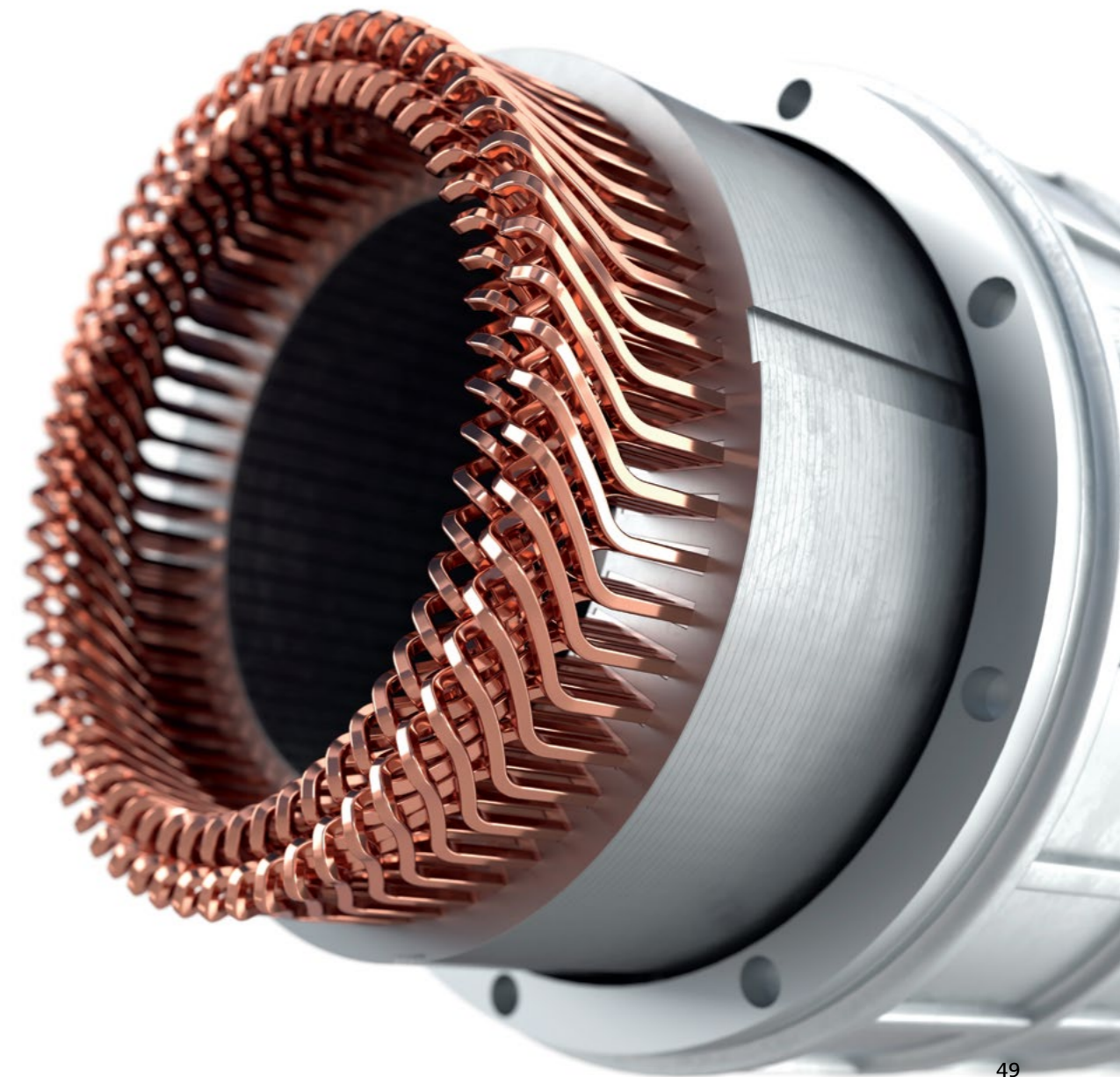



Rotor & Shaft

The rotor is comprised of the shaft and the sheet stack with built-in permanent magnets. Due to the high performance and speed of the e-motor, the rotor has very tight shape and location tolerances that require inspection. The air gap between the rotor and the stator bore is one of the main parameters defining the e-motor's performance and efficiency. It is also critical with respect to the safety and reliability of the motor.

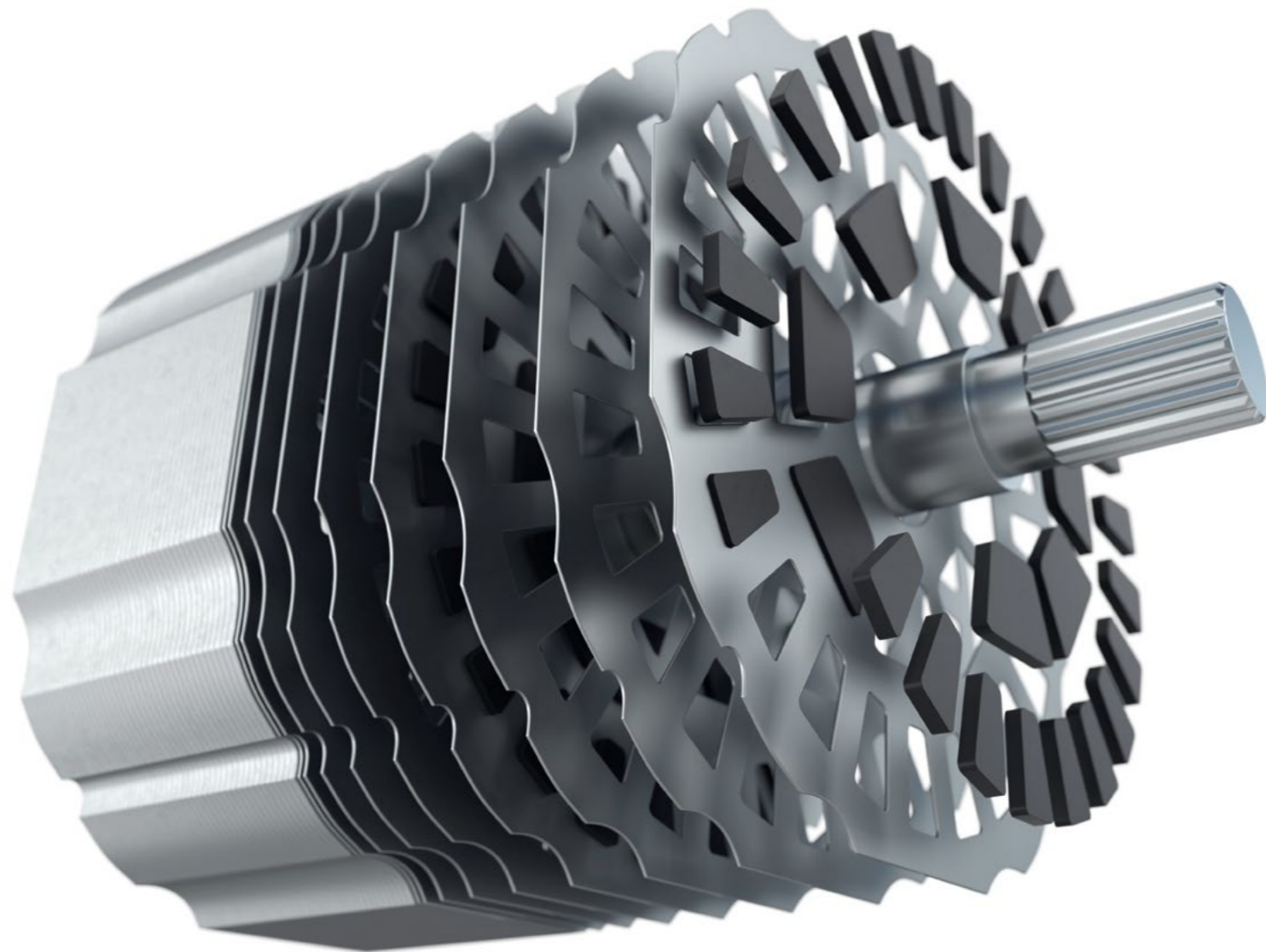

Dimensional Metrology

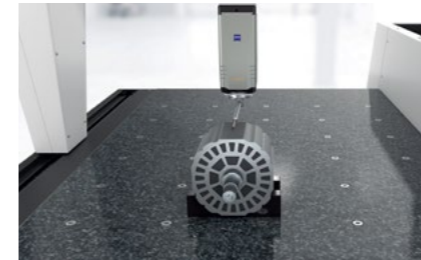

Rotor Dimensions Measuring on ZEISS CMM with Long Stylus System

All dimensional features require measurement technology that is capable and accurate under the influence of the rotor's magnetic field. The magnetic field can influence measuring results by deflecting the stylus or the inside of the probe. This makes a coordinate measuring machine that can measure the tightest tolerances with long and heavy stylus systems essential – ZEISS coordinate machines with active scanning technology are ideal for these requirements. Long stylus extensions make it possible to measure at each position of the rotor, keeping the probe far enough away from the strong magnet field to ensure stable, accurate results all around the stator.

Shape & Contour Measurement

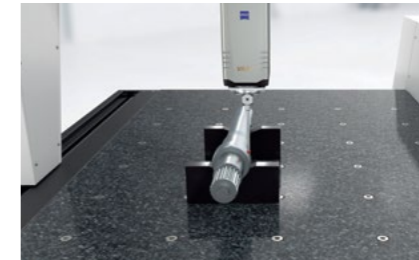

Measurement of Tight Form Characteristics on Shaft with ZEISS High Accuracy CMM

The shaft inside electric and hybrid vehicles requires very quick quality inspection, especially when it comes to shape and position tolerances due to the faster rotation speeds. As shaft geometries change and tolerances narrow, a coordinate measuring system makes it possible to remain within these narrow quantities while reducing throughput times and increasing predictability. A ZEISS coordinate measuring machine equipped with a highly accurate rotary table on air bearings and a diamond stylus kit is ideal for reliable results. Versatile coordinate measuring machines can measure shafts of all sizes.

Porosity Analysis

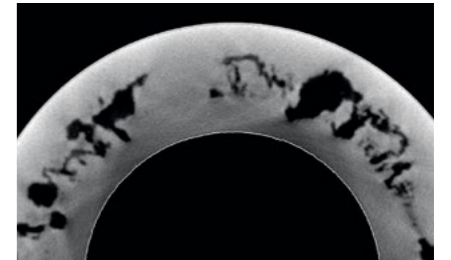

Cross section through the short circuit ring for porosity analysis

Due to the increasing speeds in the electric motors, the demands on the strength and stability of the rotors are significantly higher. In order to prevent the rotor from breaking during operation, a certain porosity level must not be exceeded. Computer tomography from ZEISS is used to determine the size and number of pores in the rotor's short-circuit ring. The recorded 3D data are then analyzed and classified by ZEISS software using the porosity analysis.



Transmission

Electric vehicles have very different powertrains – with either a single-speed or two-speed transmission instead of up to nine gears found in combustion engines. The engine and transmission share a housing – reducing the number of components and weight, but not the quality requirements. A number of measuring and inspection steps are needed to ensure top performance, low wear and tear, and quiet operation. ZEISS produces all of these measurement tools, and consults with manufacturers to design ideal quality assurance systems.



Transmission

High engine speeds of up to 20,000 rpm mean that the gearwheels in the transmission must meet very small geometric tolerances. These speeds are also demanding for the shape and position tolerances of the rotor and gear shafts, especially where the bearings and gears are located. Having the electric motor and gearbox in the same housing requires a very complex, yet lightweight design, which involves precise machining steps on the casted housing. The slightest deviations in the shape, size, position or surface texture of these components can impact the functionality and safety of the powertrain.

ZEISS has all of the measuring tools necessary to conduct such sophisticated inspections. Computer tomography can provide non-destructive detection of material defects inside of a casting for a transmission housing. High-accuracy coordinate measuring machines have sensors for dimensional, form and position tolerances as well as a roughness sensor for surface quality which can perform precision measurements of the remaining transmission components. In addition to developing groundbreaking measuring technologies, ZEISS will continue to provide advice and support to ensure customers can fully utilize the equipment in their own production facilities.

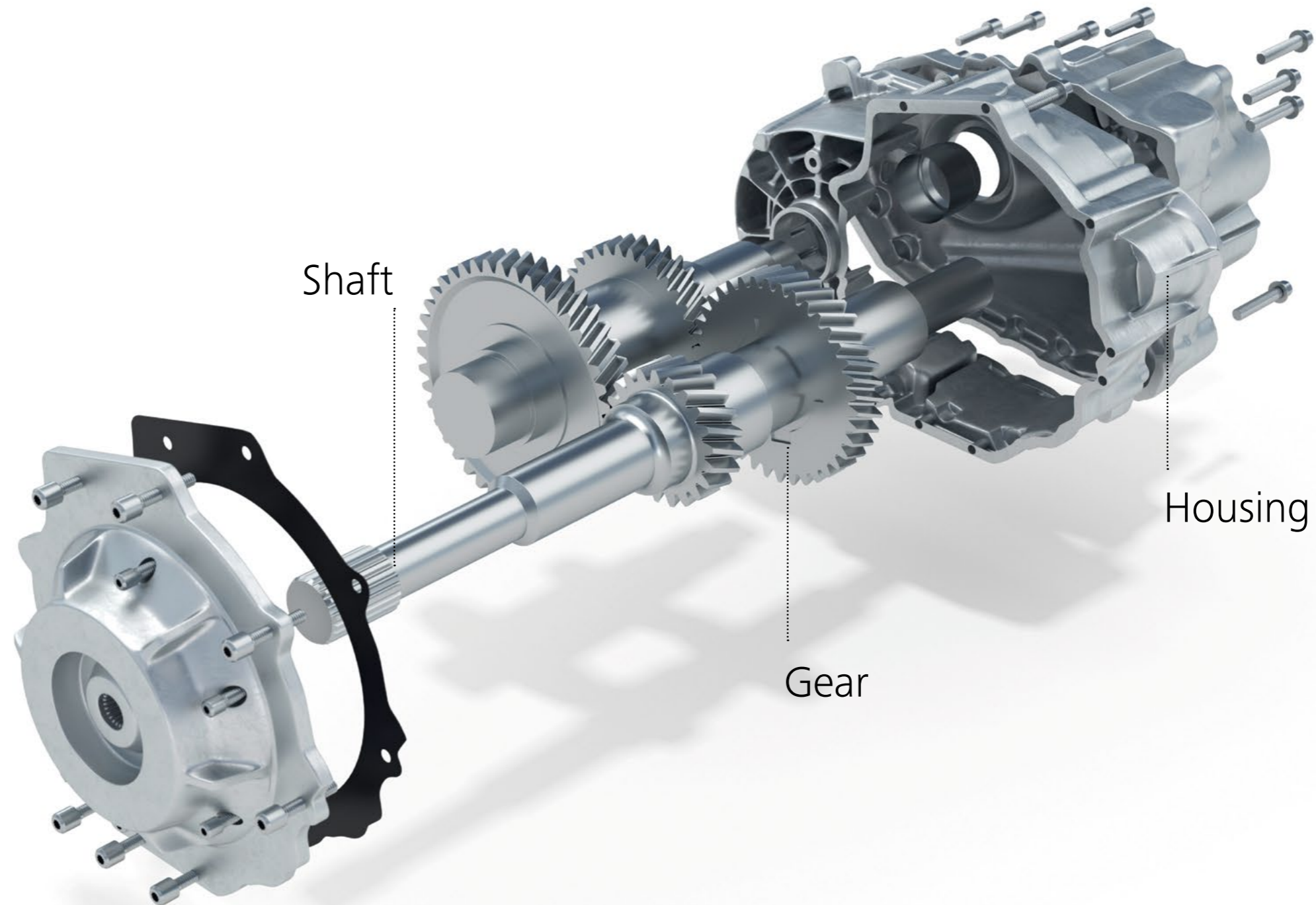



Gears

Dimensional Accuracy

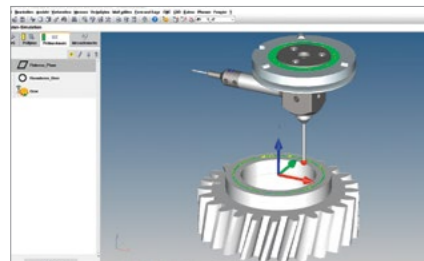

Gear Measurement on Rotary Table with ZEISS CMM and ZEISS CALYPSO

Gears for electrical cars have very tight tolerance requirements, often just a few μm , to reduce noise and harshness at revolution speeds of up to 20,000 rpm. These tolerances require fast and high-precision inspection equipment. A ZEISS coordinate measuring machine with a contact probing system and rotary table is the perfect solution for gear metrology. Measure all gear parameters as well as the shape, size and location with just one tool – for the highest accuracy and flexibility.

Complexity of Gear Parameters

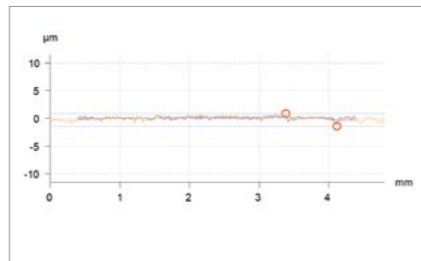

Roughness Measurement on Gear Tooth Flank and Evaluation with Roughness Plot

Gears in new energy vehicles, especially helical gears, are often optimized in relation to noise and efficiency by means of gear flank modifications (e.g. crownings, reliefs, slope modifications). Interactive, user-friendly gear metrology software is a powerful, reliable tool to handle the increasingly complex requirements regarding noise, vibration and harshness. ZEISS software solutions offer the latest reporting and data management technology for a wide range of applications.

Surface Quality

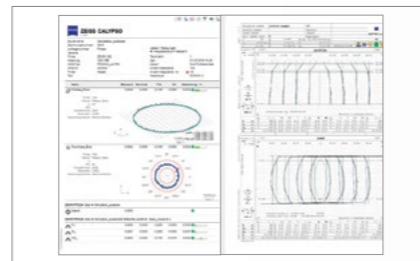
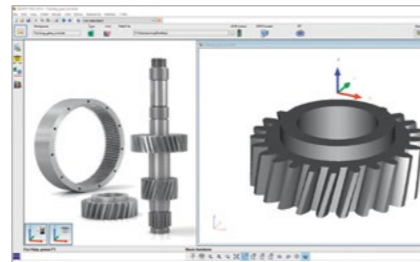

ZEISS GEAR PRO User Interface and ZEISS PiWeb Reporting Results Plot

The e-motor is virtually silent compared to combustion engines. This is why it's important to reduce any other noise created by shape, location and size deviations in the components (shaft, bearing, gear), as well as surface irregularities. Roughness and waviness parameters also play an important role. ZEISS roughness and topography sensors collect all the data – on ZEISS coordinate measurement machines and standalone high-precision systems.

Quality assurance for gears is always an important challenge – in vehicles equipped with injection combustion engines, e-motors or even hybrid engines. The number of geared parts inside electric vehicles is far lower than combustion engines. But high speeds combined with high torques and the goal of having silent, energy-efficient transmissions makes quality assurance increasingly important.



Housing

Casting Inspection



3D X-ray Scanning Data and Evaluation of Casting Defects in Cross Section

The lightweight design of the battery electric or hybrid vehicles plays an important role. Casted aluminum housings have optimized shapes and thinner walls, for improved cooling behavior and lighter weight. This extends the vehicle's traveling range, but defects in the thinner structures in the casted walls can impact the safety and cooling cycle of the e-motor and transmission. ZEISS X-ray technology effectively detects variances, preventing defective parts from going into machining process.

Dimension & Location Measurement

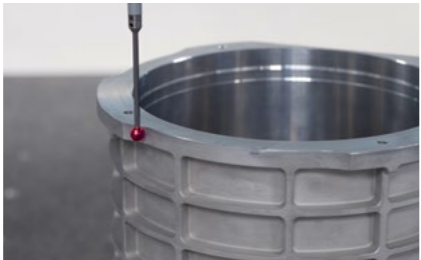

Measurement of Housing with ZEISS Tactile Scanning Technology

Integrating the e-motor and transmission into a single housing creates complex, interdependent geometries in the manufacturing process. The shape, size and location of these components have tight tolerances because of the close functional proximity to other components with high rotation speeds and torque. ZEISS tactile active scanning combined with flexible and stiff probe systems and a rotary table fulfills all inspection requirements. ZEISS reporting and quality intelligence software evaluates and visualizes the smallest deviations.

Surface & Contour Quality

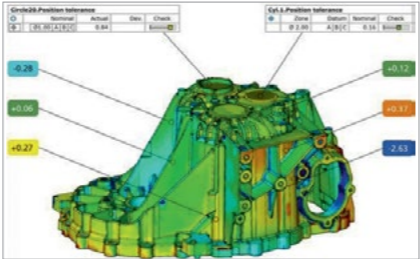

Roughness & Countour Data Acquisiting and Area Comparison of a Gearbox Housing

Inspecting the geometry, surface and contour of the housing is essential, but time-consuming. Measuring all of these factors on a single machine is much faster. A tactile roughness sensor on a ZEISS coordinate measuring machine evaluates all common surface parameters. Optical confocal whitelight technology performs high-precision contour measurements, like chamfers or radii on e.g. bores for bearings. The ATOS ScanBox 4105 from GOM is suitable for full-surface digitization of the housing. The compact measuring machine provides fully automatic surface deviations between the 3D actual coordinates and the CAD data.

The electric motor and gearbox are usually located in the same housing. This requires a very complex design, but should also be as light as possible to increase the range of the electric vehicle. This leads to very small wall thicknesses at the parts. They are usually cast from aluminum by die casting and then machined by milling. The large number of machining steps requires the measurement of many different geometric features on the housing.

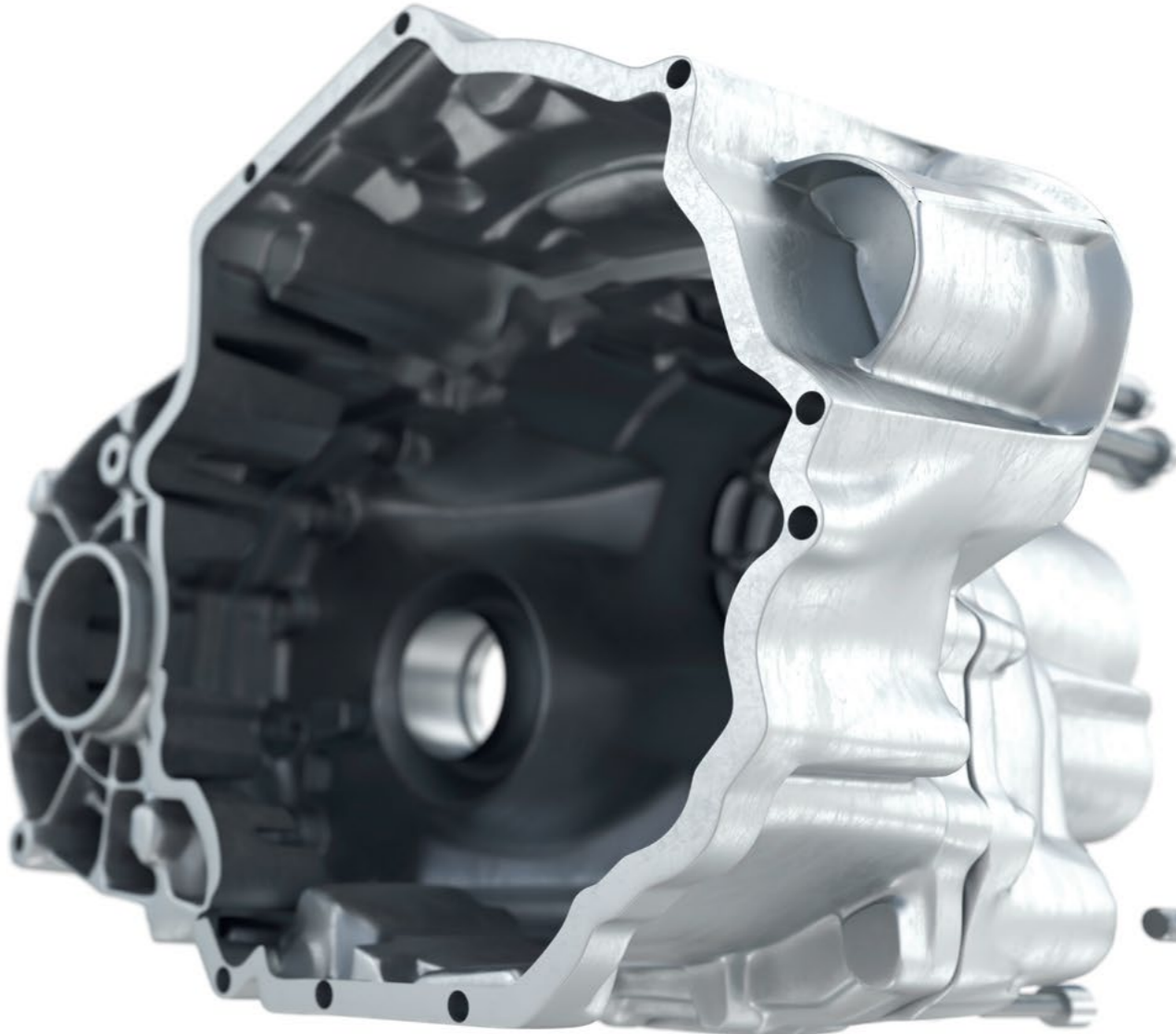



1 Meet.



Contact us to book a consultation.

2 Analyze.



Identification of specific quality demands and subsequent needs.

3 Customize.



ZEISS team customizes perfect fitting solution.

SCAN ME



ZEISS eMobility Solutions

Customize success

Battery Electronics Fuel cell system Power Electronics Transmission Electric Motor

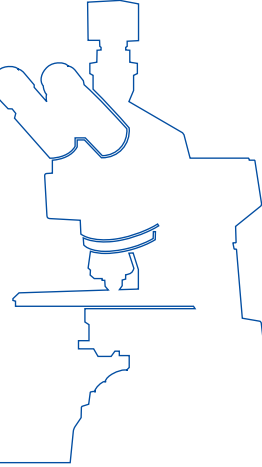
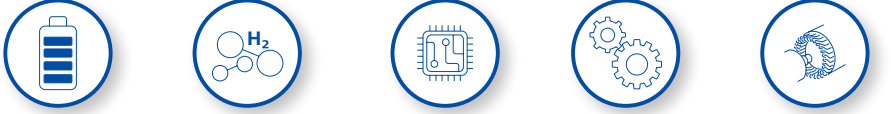

Microscopes

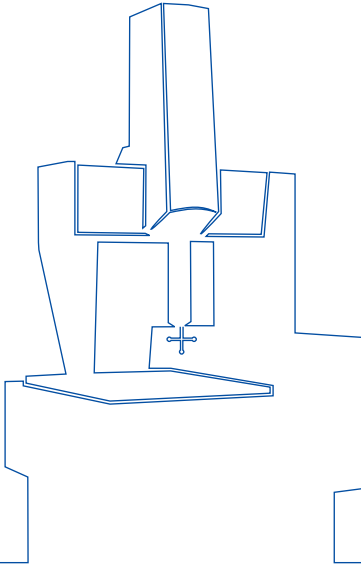

Coordinate Measuring Machines

Optical 3D Scanning

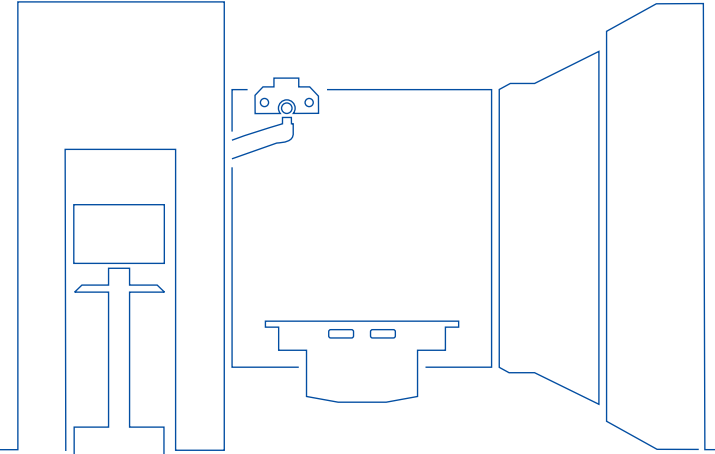

3D Measuring Machines

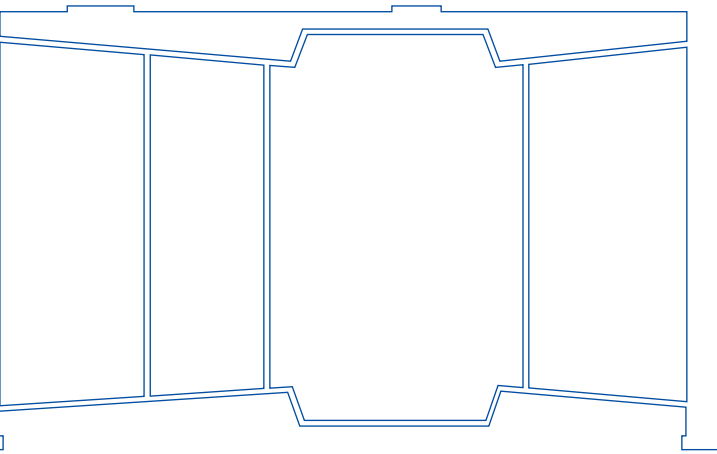

X-ray



ZEISS offers microscopy solutions for a large range of applications with excellent light, electron and X-ray microscopes and various imaging systems. For the development and quality assurance in the field of e-mobility, ZEISS is able to provide customized solutions to support the increasing demand for microstructure analysis of energy materials and optical inspection of smallest components with solutions like:

- ZEISS Smartzoom 5
- ZEISS GeminiSEM 300
- ZEISS LSM 900 Mat

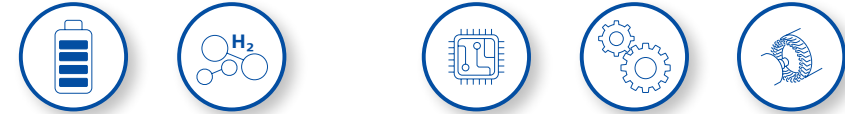

The broad portfolio of coordinate measuring machines from ZEISS combines very precise tactile and optical measurement with high measuring speed. Due to the increasing meaning of precision in the e-mobility to inspect components with very tiny tolerances coordinate measuring machines are becoming more and more important. For this ZEISS offers solutions such as:

- ZEISS PRISMO
- ZEISS CONTURA
- ZEISS O-INSPECT

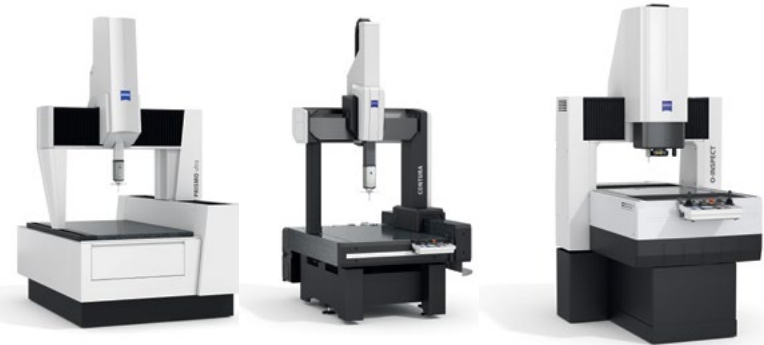

With optical 3D scanning measurement technology from ZEISS, it is possible to digitize, measure and evaluate customer requirements with high accuracy and high speed. Full-featured end of line quality control for e-motor and battery applications can be achieved with fringe projection systems or handheld laser triangulation scanner from ZEISS, like:

- ZEISS T-SCAN Hawk
- ATOS Q

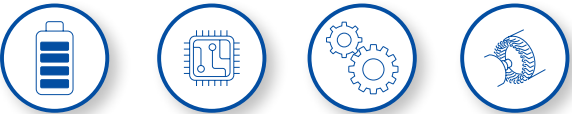

For efficient quality control of different e-mobility components, GOM includes standardized optical measuring machines in its portfolio. The systems cover every process step, from programming to automated digitization, inspection and reporting. For fully automated analyses of full-field deviations between actual 3D coordinates and CAD data, GOM offers solutions such as:

- ATOS ScanBox for eMotors
- ATOS ScanBox

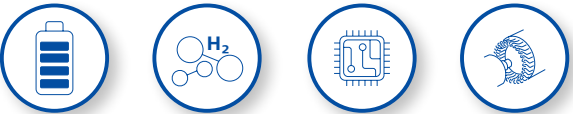

ZEISS X-Ray Series reveals non-destructively what would otherwise remain hidden from even the most watchful of eyes. To overcome e-mobility related challenges, such as safety and performance requirements, inspecting, measuring, and analyzing internal and external structures of components is crucial. To solve these challenges ZEISS offers X-ray solutions such as:

- ZEISS METROTOM
- ZEISS Xradia
- ZEISS VoluMax



Mastering Quality Together

For more information please visit:
www.zeiss.com/emobilitysolutions